

**PLANT
YOUR
VISION**

TeraPlast[™]
italian beauty



Linea **Re**

Intro **Self Watering**

Linea **Elements**

Linea **Teraguard**

Linea **Clear**

Linea **Pastel**

Linea **Colour**

Linea **Basic**

Display

Balconiere

T-basket

Linea **Flortec**

Linea **Groove**

Linea **Essential**

Linea **Classic**

Linea **City**

Linea **Luce**

Accessori

indice **PRODOTTI**
Index
Index
Verzeichnis

Linea Re

- 18 Re-Pot Hoop
- 22 Re-Pot Over
- 26 Re-Pot Cilindro/Sottovaso
- 28 Re-Pot Cassetta/Sottocassetta
- 32 Re-Pebbles

Intro Self Watering

- 48 Intro Self Watering

Linea Elements

- 54 Stem
- 56 Stalk
- 60 Stem luce/Stalk luce
- 62 Air
- 64 Hydral
- 70 Still
- 72 Aqua
- 74 Basilio
- 78 Kit balcone Hydral

Linea Teraguard

- 82 Hydral Teraguard
- 84 Kit balcone Hydral Teraguard
- 85 Air Teraguard
- 86 Still Teraguard
- 87 Aqua Teraguard

Linea Clear

- 90 Orchidea Clear
- 92 Madeira Clear
- 94 Coimbra Clear
- 96 Algarve Clear
- 98 Porto/Plato Clear
- 100 Plato Quadro Clear
- 102 Display Plato Clear
- 103 Display Plato Quadro Clear

Linea Pastel

- 106 Madeira pastel
- 108 Santiago pastel

Linea Colour

- 112 Trio Santiago

- 114 Trio Madeira
- 116 Sunrise
- 118 Orchidea
- 120 Plato
- 122 Santiago
- 124 Estoril water reserve
- 126 Porto
- 130 Algarve
- 134 Madeira Luxy
- 136 Madeira
- 138 Coimbra

Linea Basic

- 142 Cilindro colour
- 144 Cilindro classic
- 145 Campana colour
- 145 Campana classic
- 146 Ciotola coste/Vaso coste
- 147 Ciotola con sottovaso
- 148 Sottovaso colour
- 149 Sottovaso classic
- 150 Quadro colour
- 151 Quadro classic
- 152 Cassettone colour
- 153 Cassettone classic
- 154 Sottovaso Quadro color/Sottovaso Quadro
- 155 Sottocassettone colour/Sottocassettone
- 156 Cassetta mare colour
- 158 Cassetta mare classic
- 159 Cassetta Cortina
- 160 Cassetta Tirolo
- 161 Cassetta Panorama kit
- 162 Cassetta Portofino classic
- 164 Cassetta coste
- 165 kit balcone Coste/supporto Coste/supporto Mare
- 166 Sottocassetta colour
- 167 Sottocassetta classic

Display

- 168 Espositore Hydral
- 169 Espositore cilindri e sottovasi
- 170 Espositore cassette e sottocassette
- 171 Espositore cilindri
- 172 Espositore sottovasi
- 173 Espositore Hydral Teraguard

Balconiere

- 174 display kit balcone Mare 1 pz
- 175 display kit balcone Mare 2 pz

T-basket

- 178 T-Basket
- 180 T-Basket big

Linea Flortec

- 184 vaso Norma
- 186 vaso Container/vaso Crisa
- 187 vaso Basso/Gabbia verde

Linea Groove

- 190 Arena
- 196 Indy
- 200 Pixel
- 203 Sottovaso Indy
- 203 Sottovaso Pixel
- 206 Ring
- 208 Urban

Linea Essential

- 214 Divio indoor/Corner indoor
- 217 Divio outdoor/Corner outdoor
- 220 Schio cassa
- 221 Schio sottocassa
- 222 Schio Cassa Maxi
- 223 Schio Tower Maxi
- 224 Schio Tower
- 232 Schio cassa self watering
- 233 Schio cubo
- 234 Schio sottocubo
- 235 Schio cubo self watering
- 236 Schio cubo basso
- 237 Schio cubo alto
- 238 Schio cassa alta
- 239 Schio cono
- 242 Schio ciotola
- 243 Valentino/Bassano
- 244 Avila
- 246 Ribeira
- 248 Zamora
- 250 Leon
- 252 Standard One
- 253 quadro Veneto

- 255 cassa Veneto
- 256 jardinera Veneto
- 257 tondo Veneto
- 258 Pasubio quadro
- 259 Pasubio cassa
- 260 Pasubio alto

Linea Classic

- 264 Flora
- 265 cilindro Vicenza
- 266 cassetta Liscia
- 267 quadro Liscio
- 268 Africa/Tulipano
- 269 vaso festonato/vaso doppio bordo
- 270 campana Chiampo/cassetta Leonardo
- 271 cassetta Millerighe/quadro Millerighe
- 272 ciotola Castello/conca Classica
- 273 vaso Muro righe/vaso Muro liscio
- 274 sottovaso Muro/sottovaso Tondo
- 275 sottovaso Quadro/Sottocassetta

Linea City

- 278 New York
- 279 Venezia
- 280 Roma
- 281 A-Malo
- 282 Loft
- 283 Sweep

Linea Luce

- 286 Standard one outdoor
- 287 Spritz
- 288 Africa outdoor
- 289 Tulipano outdoor
- 290 Valentino outdoor
- 291 Pasubio alto outdoor
- 292 Bassano outdoor
- 293 Schio cassa alta outdoor
- 294 Schio cubo alto outdoor
- 295 Schio cono outdoor
- 296 A-malo luce outdoor

Accessori

- 298 Mover
- 300 Fix ground round/Fix ground square
- 301 Fix Wall

Legenda

Legenda

Légende

Legende



Superficie lucida
Glossy surface
Surface brillante
Glänzende Oberfläche

I vasi con la superficie lucida sono allegri e colorati. Si adattano facilmente al contesto creando un ambiente fresco e vivace.

Pots with glossy surface are jolly and bright. They be easily fit to the context, making the background fresh and vivid.

Les vases avec la surface brillante sont gais et colorés. Ils s'adaptent au contexte aisément en créant un milieu frais et vif.

Pflanzgefäße mit glänzender Oberfläche sind heiter und farbig. Sie richten sich nach dem Kontext und machen die Atmosphäre frisch und lebhaft.



Superficie opaca
Matt finished
Surface opaque
Matt-Oberfläche

I vasi con la superficie opaca sono eleganti e raffinati. Si prestano ad arredare i tuoi spazi con gusto e armonia.

Pots with matt surface are elegant and refined. They are fit to furnish your space with taste and harmony.

Les vases avec la surface opaque sont élégants et raffinés. Ils se prêtent à meubler vos espaces avec goût et harmonie.

Pflanzgefäße mit matter Oberfläche sind elegant und verfeinert. Ideal um Ihren Raum durch Geschmack und Harmonie auszustatten.



sottovaso / saucer
soucoupes / untersetzer



sacchetto / bag
sachets /beutel



sfuso / loose pieces
en vrac / lose Stk



display pallet



pallet di scatole
pallet of carton boxes



scatola / box
carton / karton



pallet



fix ground



fix wall



supporto Cassetta Coste
Iron support for Cassetta Coste
Support pour jardinière Coste
Träger für die Cassetta Coste



supporto Cassetta Mare
Iron support for Cassetta Mare
Support pour Cassetta Mare
Träger für die Cassetta Mare



Self Watering

SELF WATERING

La riserva d'acqua permette di alimentare le vostre piante senza bisogno di irrigarle spesso.

Self-watering system allows to feed plants without needing to irrigate it often.

La réserve d'eau permet d'alimenter vos plantes sans besoin de leur irriguer souvent.

Das Wasserspeicher ermöglicht es, die Pflanzen zu versorgen, ohne oft zu begießen.



Evita l'annidamento di zanzare e altri insetti.

It stops mosquitoes and other insects from laying eggs.

Évite la nidation des moustiques et autres insectes.

Das Einnisten von Mücken und anderen Insekten wird verhindert.



Leggerissimo

Very light

Très léger

Sehr Leicht



U.V. RESISTANT

Inalterabile nel colore

Colourfast dyes

Inalterabilité des couleurs

Farbbeständig



Resistente al caldo e al freddo

Warm and cold resistant

Résistant à la chaleur et au froid

Wetterfest



Sottovaso incluso
Saucer included
Soucoupe intégrée
Integrierter unterstzer



Resistente agli urti
Shock resistant
Résistant aux chocs
Stoß und Bruchfest



RECYCLABLE

Ecologico: atossico e riciclabile

Ecological: non-toxic and recyclable

Ecologique: recyclable et not toxique

Umweltfreundlich: nicht toxisch und recyclingfähig

Siamo molto orgogliosi del nostro impianto fotovoltaico da 1,17 MW, posizionato sui tetti dei reparti produttivi e del magazzino, con il quale produciamo energia pulita per poter produrre i nostri vasi. Questa scelta, insieme all'utilizzo di materie prime riciclate di alta qualità e a politiche atte ad evitare sprechi in fase di imballaggio, rende Teraplast uno dei produttori di vasi più sostenibile.

We are very proud of our photovoltaic installation of 1,17 MW, placed on the roof of our production and warehouse, wherewith we produce clean energy to produce our pots. This choice, together with the use of high quality recycled raw material and strict policies to avoid wastes in the packaging process, emphasizes Teraplast as one of the most environmental friendly company.

Nous sommes très fiers de notre installation photovoltaïque de 1,17 MW, positionné sur les toits des rayons productifs et du magasin avec laquelle nous produisons énergie propre pour pouvoir produire nos vases. Avec le choix d'utiliser des matières premières recyclées de haute qualité en contribuant à la politique d'antigaspiages en phase d'emballage, Teraplast devient un des producteurs de vases les plus respectables.

Wir sind sehr stolz auf unsere Photovoltaikanlage mit 1,17 MW, auf dem Werk- und Lagerdach, womit wir saubere Energie erzeugen, um unsere Töpfe herzustellen. Diese Entscheidung, zusammen mit der Verwendung von recycelt hochwertigen Rohstoffe und ohne Verschwendungen in der Verpackungsphase, macht TeraPlast einer der am nachhaltigsten Hersteller von Pflanzgefäße.



Con lampadina
Illuminated
Lumineux
Mit licht



Facilmente lavabile senza detersivi
Easy to wash without detergents
Très facile à entretenir
Einfach ohne Reinigungsmittel waschbar



ANTI-MOLD

Impedisce la formazione di muffe
They prevent mould from growing
Prévient la formation de moisissures
Verhindert Schimmelbildung



Impilabile
Stackable
Impilables
Stapelbar

Per agevolare il trasporto e la vendita a scaffale molti dei nostri vasi sono impilabili.

A wide range of our pots are stackable in order to ensure easy transportation and friendly merchandising.

Pour faciliter le transport et la vente en étagères beaucoup de nos vases sont impilables.

Unsere Pflanzgefäße sind stapelbar, um den Transport und den Verkauf auf Regale zu erleichtern.



Foro predisposto
Can be drilled to drainage
Trous de drainage prévus
Loch Vorsatz

I vasi con il foro predisposto possono essere facilmente forabili per permettere il drenaggio dell'acqua. Una volta effettuata questa operazione si consiglia l'abbinamento con il sottovaso adeguato.

Pre drilled pots can be easily drilled to allow the drain of the water. Once done this operation we recommend to combine them with the suitable saucer.

Les vases qui ont le trou prépercé peuvent favoriser le drainage de l'eau. Une fois cette opération effectuée veuillez demander conseil au distributeur afin de trouvé le dessous de pot correspondant.

Pflanzgefäße mit vorgesehenem Loch sind einfach durchzulöchern für den Wasserdränage. Nach dem Durchlöchern ist die Benutzung des anpassenden Untersetzters zu empfehlen.



PLANT YOUR VISION

**POTS AND PEBBLES
WITH A "GREEN SOUL",
MADE OF SUSTAINABLE,
RECYCLED AND
RECYCLABLE PLASTIC**

IT

Vasi e sassi dall'anima "green", prodotti con plastica ecosostenibile riciclata e riciclabile.

DE

Pflanzgefäße und Steine mit einer „grünen“ Seele, aus umweltfreundlichem, recyceltem und recycelbarem Kunststoff.

FR

Pots et cailloux produits avec une âme « verte », fabriqués avec du plastique écodurable, recyclé et recyclable.





TERAPLAST A SECOND LIFE FOR PLASTIC

IT

TERAPLAST,
LA SECONDA
VITA DELLA
PLASTICA

DE

TERAPLAST,
DAS ZWEITE
LEBEN FÜR
KUNSTSTOFF

FR

TERAPLAST,
LA SECONDE VIE
DU PLASTIQUE

IT

La plastica è un materiale riciclabile al 100%, per questo è una delle risorse più efficienti dal punto di vista energetico. Teraplast, da sempre attenta alla sostenibilità ambientale, crede nell'economia circolare, un sistema economico pensato per rigenerarsi da solo, che garantisce una riduzione degli sprechi e delle emissioni grazie al riciclo, al riutilizzo, al mantenimento, e alla riparazione delle materie plastiche: un prodotto in plastica alla fine del suo ciclo di vita può essere riciclato e reinserito nel sistema produttivo per creare un prodotto di qualità equivalente al prodotto originale da cui si è partiti. Riciclo e dona anche tu alla plastica una seconda vita!

DE

Kunststoff ist ein zu 100 % recycelbares Material und damit eine der energieeffizientesten Ressourcen. Teraplast achtet stets auf ökologische Nachhaltigkeit und glaubt an die Kreislaufwirtschaft, ein Wirtschaftssystem, das eine Selbstregenerierung vorsieht und durch Recycling, Wiederverwendung, Instandhaltung und Reparatur von Kunststoffen eine Reduzierung von Abfall und Emissionen garantiert: Ein Kunststoffprodukt kann am Ende seines Lebenszyklus recycelt und dem Produktionssystem wieder zugeführt werden, um ein Produkt in der gleichen Qualität wie das Ursprungsprodukt herzustellen. Recyceln auch Sie und geben Sie Kunststoff ein zweites Leben!

FR

Le plastique est une matière 100 % recyclable. C'est pour cette raison qu'il est l'une des ressources les plus efficaces du point de vue énergétique. L'entreprise Teraplast, depuis toujours attentive à la viabilité environnementale, croit fortement dans l'économie circulaire, un système économique conçu pour se régénérer lui-même, garantissant une réduction du gaspillage et des émissions grâce au recyclage, à la récupération, au maintien et à la réparation des matières plastiques : un produit en plastique qui a atteint la fin de son cycle de vie peut être recyclé et réintégré dans le système de production, afin de concevoir un produit de qualité équivalente au produit d'origine servant de base. Recyclez et offrez vous aussi une seconde vie au plastique !

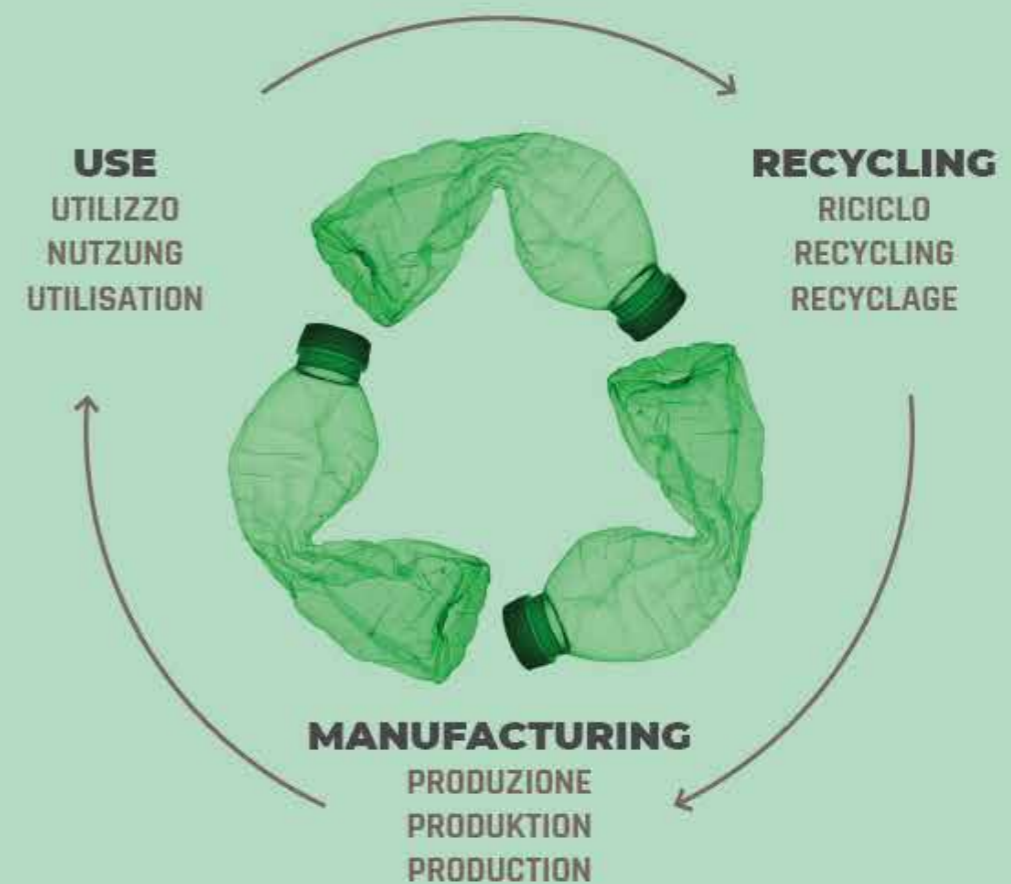

16 = **1**
BOTTLES
OF WATER **RE-POT**
 diameter 30 cm / 11 ¾", height 28 cm / 11"

IT

16 bottigliette d'acqua = 1 Vaso RE-POT
 (diametro 30 cm, altezza 28 cm)

DE

16 Wasserflaschen = 1 RE-POT Topf
 (Durchmesser 30 cm, Höhe 28 cm)

FR

16 petites bouteilles d'eau = 1 Pot RE-POT
 (diamètre 30 cm, hauteur 28 cm)



All of this is behind Teraplast's new Linea RE: a sustainable way to look to the future. The pots and decorative pebbles in the selection are non-toxic, recycled and 100% recyclable. RE stands for RESPECT and care for the environment. The eco-friendly products are made using sustainable plastic that reduces their environmental impact and cuts carbon dioxide emissions. Do you want to play your part in the fight to protect the environment by buying responsibly? If so, join the RE generation: RE-CYCLE plastic and sow the seeds of the future!

IT

Partendo da questi presupposti Teraplast ha creato la Linea RE, il modo ecosostenibile di guardare al futuro: una linea di vasi e sassi decorativi atossici, riciclati, e riciclabili al 100%. RE come RESPECT, per indicare l'attenzione e il rispetto per l'ambiente: prodotti eco-friendly realizzati con una plastica amica che riduce l'impatto ambientale, diminuendo le emissioni di CO₂. Vuoi contribuire anche tu a proteggere l'ecosistema acquistando responsabilmente? Allora entra nella generazione RE: RE-CICLA la plastica e semina il futuro!

DE

Vor diesem Hintergrund hat Teraplast Linea RE entwickelt, um umweltschonend in die Zukunft zu blicken: eine Produktlinie mit ungiftigen, recycelten und zu 100 % recycelbaren Pflanzgefäßen und Dekosteinen. RE wie RESPEKT steht für Rücksichtnahme auf die Umwelt: umweltfreundliche Produkte aus nachhaltigem Kunststoff, der die Umweltbelastung verringert und die CO₂-Emissionen reduziert. Möchten Sie durch verantwortungsbewusstes Einkaufen zum Schutz des Ökosystems beitragen? Dann sind Sie bei der Generation RE genau richtig: RE-CYCELN Sie Kunststoffe und säen Sie für die Zukunft!

FR

Partant de ce principe, Teraplast a créé la ligne Linea RE, le moyen écodurable d'envisager l'avenir : une gamme de pots et de cailloux de décoration non toxiques, recyclés et 100 % recyclables. RE comme RESPECT, pour indiquer l'attention et le respect de l'environnement : des produits non polluants, réalisés avec un plastique ami qui réduit l'impact environnemental, diminuant les émissions de CO₂. Vous souhaitez contribuer vous aussi à la protection de l'écosystème en achetant de manière responsable ? Alors entrez dans la génération RE : RE-CYCLEZ le plastique et semez les graines du futur !

RE RESPECT

All Teraplast products in the Linea RE are made using 100% recycled plastic granules, without adding other substances or colouring agents.

IT

Teraplast realizza tutti i prodotti della Linea RE utilizzando granuli riciclati al 100%, senza aggiungere altre sostanze o coloranti.

DE

Teraplast stellt alle Linea RE Artikel aus 100 % recyceltem Granulat her, ohne Zugabe von anderen Stoffen oder Farbstoffen.

FR

Teraplast fabrique tous les produits de la ligne Linea RE en utilisant des granules 100 % recyclés, sans ajouter d'autres substances ou colorants.





RE POTS

Five colours, unique shades that are always different for every single item, and a distinctive wrinkled texture on the surface to give a more natural, appealing look and feel to the products: Teraplast pots decorate spaces in style, thanks to their striking, sophisticated visual details.

IT

Cinque colori, sfumature uniche e sempre diverse per ogni singolo pezzo, superfici dalla rugosità particolare per maggior piacevolezza e naturalezza alla vista e al tatto: i vasi Teraplast arredano con stile gli spazi, grazie a dettagli estetici ricercati e di grande effetto.

DE

Fünf Farben, einzigartige und immer wieder andere Nuancen für jedes einzelne Stück, spezielle raue Oberflächen für eine ansprechende natürlichere Optik und eine angenehme Haptik: Pflanzgefäße von Teraplast verleihen dem Ambiente dank raffinierter und beeindruckender ästhetischer Details ein stilvolles Aussehen.

FR

Déclinés en cinq coloris et offrant des nuances uniques et toujours différentes d'un article à un autre, ainsi que des surfaces à la rugosité particulière pour une sensation agréable et naturelle à la vue comme au toucher, les pots Teraplast décorent avec style les espaces grâce à leurs détails esthétiques raffinés et impressionnants.



RE-POT Hoop

FIVE COLOURS AND
FOUR DIFFERENT SIZES,
ALL OF WHICH COME WITH
A SELF-WATERING SYSTEM

IT

Cinque colori per quattro diverse
misure, ciascuna con sistema
self watering già incluso.

DE

Fünf Farben für vier verschiedene
Größen, jeweils inklusive Selbst-
bewässerungssystem.

FR

Cinq coloris pour quatre dimensions
différentes, chacune disposant du
système self watering.

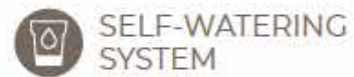

code 237

White

Bianco

Weiß

Blanc



code 241

Grey

Grigio

Grau

Gris



code 238

Black

Nero

Schwarz

Noir



code 240

Brown

Marrone

Braun

Marron



code 239

Green

Verde

Grün

Vert



SELF-WATERING SYSTEM

The self-watering system allows you to cater to your plants' needs without having to water them too often. The drainage holes let out any excess water, so that the plant itself can draw on the contents of the reservoir when it needs them. Some of the pots equipped with this system also have a coating membrane that can be removed to let excess water leak out.



IT

La riserva d'acqua permette di alimentare le vostre piante senza bisogno di irrigarle spesso. I fori di drenaggio permettono di scaricare eventuali eccessi d'acqua, così sarà la pianta stessa ad attingere alla riserva quando ne avrà bisogno. Alcuni vasi dotati di questo sistema presentano anche una membrana di rivestimento che, una volta rimossa, permette all'acqua in eccesso di fuoriuscire dal vaso.

DE

Der Wasserspeicher ermöglicht es Ihnen, Ihre Pflanzen zu versorgen, ohne sie häufig bewässern zu müssen. Durch die Entwässerungslöcher wird überschüssiges Wasser abgeleitet, sodass die Pflanze selbst bei Bedarf aus dem Wasservorrat schöpft. Einige der mit diesem System ausgestatteten Pflanzgefäße sind auch mit einer Beschichtung versehen. Wird diese entfernt, kann überschüssiges Wasser aus dem Topf entweichen.

FR

La réserve d'eau permet d'alimenter vos plantes sans devoir les arroser souvent. Les trous de drainage vous permettent d'évacuer toute l'eau en excès de sorte que la plante puisera elle-même dans la réserve d'eau selon ses besoins. Certains des pots équipés de ce système disposent également d'une membrane de revêtement qui, une fois retirée, permet à l'excès d'eau de s'évacuer.



NO MOSQUITO EGGS

Farewell mosquitoes, this is a no-fly zone! The self-watering system stops mosquitoes from reaching the stagnant water at the bottom of pots and laying their eggs there.

IT

Addio zanzare questa è una No-fly zone! La riserva d'acqua impedisce alle zanzare di raggiungere l'acqua ferma sul fondo del vaso per depositare le uova.

DE

Mücken Ade, dies ist eine Flugverbotszone! Der Wasserspeicher verhindert, dass Mücken das stehende Wasser auf dem Boden des Pflanzgefäßes erreichen, um Eier zu legen.

FR

Adieu les moustiques, c'est une zone interdite au vol! La réserve d'eau empêche les moustiques d'atteindre l'eau stagnante au fond du pot pour y déposer leurs œufs.

TECH SPECS

- ecological: non-toxic and recyclable**
ecologico: atossico e riciclabile
umweltfreundlich: nicht toxisch und recyclingfähig
écologique : recyclable et non toxique
- UV resistant: colour-fast dyes**
resistente ai raggi UV: inalterabile nel colore
UV-beständig: farbbeständig
résistant aux UV : inaltérabilité des couleurs
- weather resistant (-30°C to +60°C)**
resistente al caldo e freddo (-30°C a +60°C)
wetterfest (-30°C bis +60°C)
résistant à la chaleur et au froid (-30 °C à +60 °C)
- stackable**
impilabile
stapelbar
empilables
- easy to wash without detergents**
lavabile senza detersivi
einfach ohne Reinigungsmittel waschbar
très facile à entretenir
- anti-mould**
anti muffa
Anti-Schimmel
anti-moisissure
- shock resistant**
resistente agli urti
stoß- und bruchfest
résistant aux chocs
- lightweight**
leggerissimo
sehr leicht
très léger
- the drainage hole allows excess water to leak from the pot**
foro predisposto
Wasseraustrittsloch vorhanden
trous de drainage prévus



CODE	33 703 016	33 703 020	33 703 025	33 703 030
	237 238 239 240 241	237 238 239 240 241	237 238 239 240 241	237 238 239 240 241
Ø cm / inches	16 / 6 ¼	20 / 7 ¾	25 / 9 ¾	30 / 11 ¾
h cm / inches	15 / 5 ¾	19 / 7 ½	23,5 / 9 ¼	28 / 11
litres	1,6	3,2	6,2	11,8
minimum package (pcs)	12 33x17x33h / 13x6¼x13	8 21x21x43h / 8¼x8¼x16¼	6 20x26x42h / 7¼x10¼x16¼	6 31x31x44h / 12¼x12¼x17¼
pcs pallet	1008 80x120x230h / 31¼x47¼x90¼	600 80x120x230h / 31¼x47¼x90¼	360 80x120x230h / 31¼x47¼x90¼	180 80x120x230h / 31¼x47¼x90¼



RE-POT Over



FIVE COLOURS AND THREE DIFFERENT SIZES, ALL OF WHICH COME WITH A SELF-WATERING SYSTEM



code 237

White
Bianco
Weiß
Blanc



code 241

Grey
Grigio
Grau
Gris



code 238

Black
Nero
Schwarz
Noir



code 240

Brown
Marrone
Braun
Marron



code 239

Green
Verde
Grün
Vert

IT
Cinque colori per tre diverse misure, ciascuna con sistema self watering già incluso.

DE
Fünf Farben für drei verschiedene Größen, jeweils inklusive Selbstbewässerungssystem.

FR
Cinq coloris pour trois dimensions différentes, chacune disposant du système self watering.



SELF-WATERING SYSTEM

The self-watering system allows you to cater to your plants' needs without having to water them too often. The drainage holes let out any excess water, so that the plant itself can draw on the contents of the reservoir when it needs them. Some of the pots equipped with this system also have a coating membrane that can be removed to let excess water leak out.



IT

La riserva d'acqua permette di alimentare le vostre piante senza bisogno di irrigarle spesso. I fori di drenaggio permettono di scaricare eventuali eccessi d'acqua, così sarà la pianta stessa ad attingere alla riserva quando ne avrà bisogno. Alcuni vasi dotati di questo sistema presentano anche una membrana di rivestimento che, una volta rimossa, permette all'acqua in eccesso di fuoriuscire dal vaso.

DE

Der Wasserspeicher ermöglicht es Ihnen, Ihre Pflanzen zu versorgen, ohne sie häufig bewässern zu müssen. Durch die Entwässerungslöcher wird überschüssiges Wasser abgeleitet, sodass die Pflanze selbst bei Bedarf aus dem Wasservorrat schöpft. Einige der mit diesem System ausgestatteten Pflanzgefäße sind auch mit einer Beschichtung versehen. Wird diese entfernt, kann überschüssiges Wasser aus dem Topf entweichen.

FR

La réserve d'eau permet d'alimenter vos plantes sans devoir les arroser souvent. Les trous de drainage vous permettent d'évacuer toute l'eau en excès de sorte que la plante puisera elle-même dans la réserve d'eau selon ses besoins. Certains des pots équipés de ce système disposent également d'une membrane de revêtement qui, une fois retirée, permet à l'excès d'eau de s'évacuer.



NO MOSQUITO EGGS

Farewell mosquitoes, this is a no-fly zone! The self-watering system stops mosquitoes from reaching the stagnant water at the bottom of pots and laying their eggs there.

IT

Addio zanzare questa è una No-fly zone! La riserva d'acqua impedisce alle zanzare di raggiungere l'acqua ferma sul fondo del vaso per depositare le uova.

DE

Mücken Ade, dies ist eine Flugverbotszone! Der Wasserspeicher verhindert, dass Mücken das stehende Wasser auf dem Boden des Pflanzgefäßes erreichen, um Eier zu legen.

FR

Adieu les moustiques, c'est une zone interdite au vol! La réserve d'eau empêche les moustiques d'atteindre l'eau stagnante au fond du pot pour y déposer leurs œufs.

TECH SPECS

- **ecological: non-toxic and recyclable**
ecologico: atossico e riciclabile
umweltfreundlich: nicht toxisch und recyclingfähig
écologique : recyclable et non toxique
- **UV resistant: colour-fast dyes**
resistente ai raggi UV: inalterabile nel colore
UV-beständig: farbbeständig
résistant aux UV : inaltérabilité des couleurs
- **weather resistant (-30°C to +60°C)**
resistente al caldo e freddo (-30°C a +60°C)
wetterfest (-30°C bis +60°C)
résistant à la chaleur et au froid (-30 °C à +60 °C)
- **stackable**
impilabile
stapelbar
empilables
- **easy to wash without detergents**
lavabile senza detersivi
einfach ohne Reinigungsmittel waschbar
très facile à entretenir
- **anti-mould**
anti muffa
Anti-Schimmel
anti-moisissure
- **shock resistant**
resistente agli urti
stoß- und bruchfest
résistant aux chocs
- **lightweight**
leggerissimo
sehr leicht
très léger
- **the drainage hole allows excess water to leak from the pot**
foro predisposto
Wasseraustrittsloch vorhanden
trous de drainage prévus

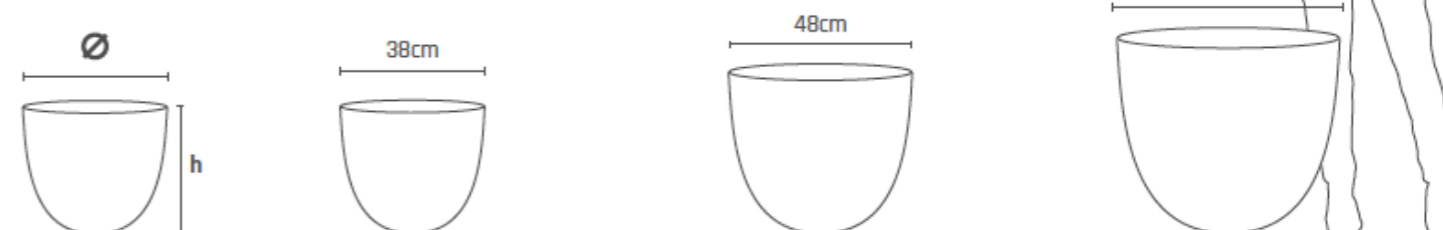

CODE	33 706 038	33 706 048	33 706 058
	237 238 239 240 241	237 238 239 240 241	237 238 239 240 241
Ø cm / inches	38 / 15	48 / 18 3/4	58 / 22 3/4
h cm / inches	32 / 12 3/4	40 / 15 3/4	47 / 18 1/2
litres	24	50	85
minimum package (pcs)	5 38x38x62h / 15x15x24 3/4	2 48x48x50h / 18 3/4x18 3/4x19 3/4	2 58x58x58h / 22 3/4x22 3/4x22 3/4
pcs pallet	150 80x120x230h / 31 1/2x47 1/4x90 1/2	72 100x115x220h / 39 1/2x45 1/4x86 1/2	32 80x120x230h / 31 1/2x47 1/4x90 1/2

RE-POT Cilindro



RE-POT Sottovaso



code 001

Terracotta colour

Terracotta

Terrakotta

Terracotta

code 005

Anthracite

Antracite

Anthrazit

Anthracite

code 406

Brown

Bruno

Braun

Brun

TECH SPECS



- **ecological: non-toxic and recyclable**
ecologico: atossico e riciclabile
umweltfreundlich: nicht toxisch und recyclingfähig
écologique : recyclable et non toxique



- **UV resistant: colour-fast dyes**
resistente ai raggi UV: inalterabile nel colore
UV-beständig: farbbeständig
résistant aux UV : inaltérabilité des couleurs



- **weather resistant (-30°C to +60°C)**
resistente al caldo e freddo (-30°C a +60°C)
wetterfest (-30°C bis +60°C)
résistant à la chaleur et au froid (-30 °C à +60 °C)



- **stackable**
impilabile
stapelbar
empilables



- **easy to wash without detergents**
lavabile senza detersivi
einfach ohne Reinigungsmittel waschbar
très facile à entretenir



- **anti-mould**
anti muffa
Anti-Schimmel
anti-moisissure



- **shock resistant**
resistente agli urti
stoß- und bruchfest
résistant aux chocs



- **lightweight**
leggerissimo
sehr leicht
très léger



- **the drainage hole allows excess water to leak from the pot**
foro predisposto
Wasseraustrittsloch vorhanden
trous de drainage prévus

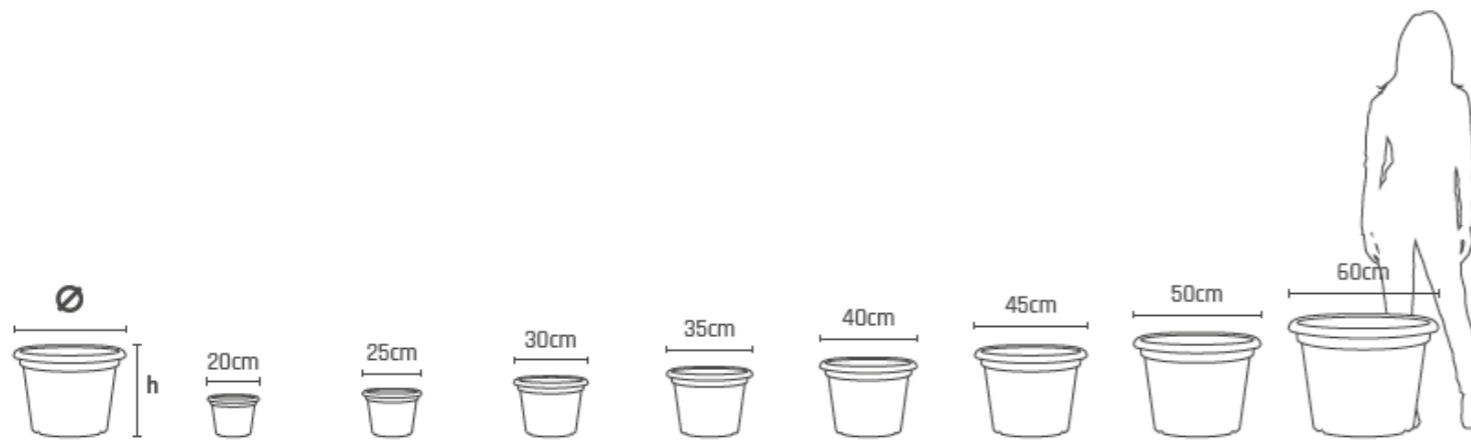

CODE	33 001 020	33 001 025	33 001 030	33 001 035	33 001 040	33 001 045	33 001 050	33 001 060
	001 005 406	001 005 406	001 005 406	001 005 406	001 005 406	001 005 406	001 005 406	001 005 406
Ø cm / inches	20 / 7 7/8	25 / 9 7/8	30 / 11 3/4	35 / 13 3/4	40 / 15 3/4	45 / 17 3/4	50 / 19 3/4	60 / 22 3/4
h cm / inches	14,2 / 5 1/2	17,7 / 7	21,2 / 8 3/8	24,6 / 9 5/8	27,2 / 10 3/4	31,4 / 12 3/8	34,9 / 13 3/8	41,8 / 16 1/2
litres	2,5	4,8	8,5	13	19	29	41	69
Ø cm	18	22	26	30	35	40	45	52
minimum package (pcs)	20 20x20x36h 7 7/8x7 7/8x14 1/4	10 25x25x30h 9 7/8x9 7/8x11 1/4	10 30x30x34h 11 3/4x11 3/4x13 3/8	10 35x35x39h 13 3/8x13 3/8x15 3/8	10 40x40x42h 15 3/8x15 3/8x16 1/2	10 45x45x46h 17 3/8x17 3/8x18 1/4	5 50x50x42h 19 3/4x19 3/4x16 1/2	5 60x60x50h 22 3/4x22 3/4x19 3/4

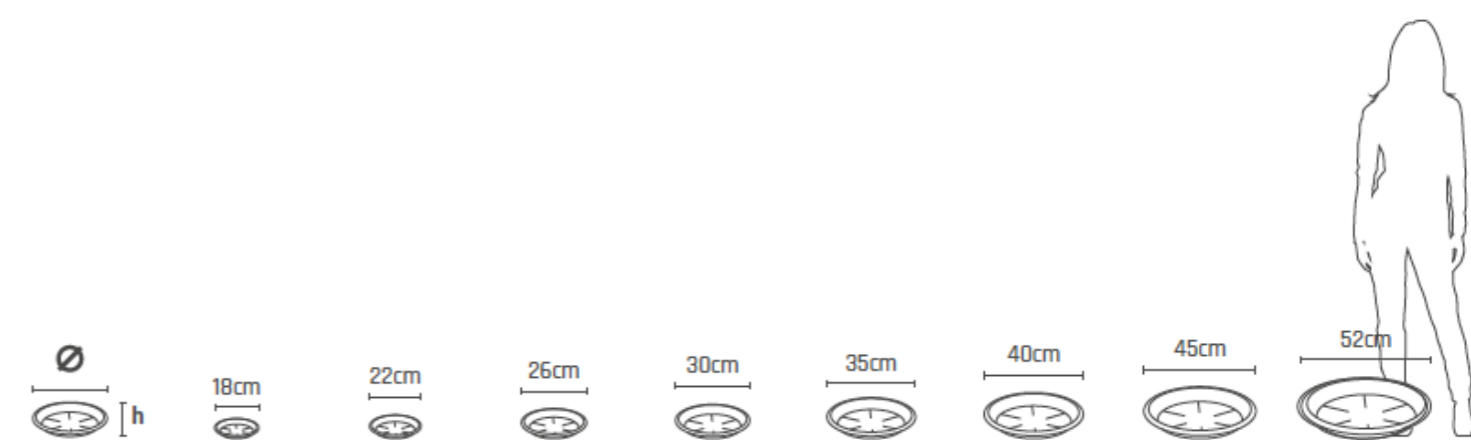

CODE	33 011 018	33 011 022	33 011 026	33 011 030	33 011 035	33 011 040	33 011 045	33 011 052
	001 005 406	001 005 406	001 005 406	001 005 406	001 005 406	001 005 406	001 005 406	001 005 406
Ø cm / inches	18 / 7 1/8	22 / 8 5/8	26 / 10 1/4	30 / 11 3/4	35 / 13 3/4	40 / 15 3/4	45 / 17 3/4	52 / 20 3/4
h cm / inches	2,3 / 3/8	3 / 1 1/8	3,7 / 1 1/2	4,1 / 1 5/8	5,1 / 2	5,2 / 2 1/8	5,5 / 2 1/4	6,6 / 2 5/8
minimum package (pcs)	20 18x18x8,5h 7 1/8x7 1/8x3 3/8	10 22x22x6h 8 5/8x8 5/8x2 3/8	20 26x26x24h 10 1/4x10 1/4x9 3/8	10 30x30x15h 11 3/4x11 3/4x5 7/8	10 35x35x15h 13 3/4x13 3/4x5 7/8	10 40x40x15h 15 3/4x15 3/4x5 7/8	5 45x45x17h 17 3/4x17 3/4x6 5/8	5 52x52x20h 20 3/4x20 3/4x7 7/8

RE-POT Cassetta Mare



RE-POT Sottocassetta Mare



code 001

Terracotta colour

Terracotta

Terrakotta

Terracotta

code 005

Anthracite

Antracite

Anthrazit

Anthracite

code 406

Brown

Bruno

Braun

Brun



CODE	33 004 040 001 005 406	33 004 050 001 005 406	33 004 060 001 005 406	33 004 080 001 005 406
a cm / inches	40 / 15 ¾	50 / 19 ¾	60 / 22 ¾	80 / 31 ½
b h cm / inches	b = 17 / 6 ¾ h = 14,5 / 5 ¾	b = 17 / 6 ¾ h = 14,5 / 5 ¾	b = 17 / 6 ¾ h = 14,5 / 5 ¾	b = 17 / 6 ¾ h = 14,5 / 5 ¾
litres	6	8	10	12
minimum package (pcs)	40 10 40x17x30h 15%x6%x11%	50 10 50x17x30h 19%x6%x11%	60 10 60x17x30h 22%x6%x11%	80 10 80x17x30h 31½%x6%x11%

TECH SPECS

- **ecological: non-toxic and recyclable**
ecologico: atossico e riciclabile
umweltfreundlich: nicht toxisch und recyclingfähig
écologique : recyclable et non toxique
- **UV resistant: colour-fast dyes**
resistente ai raggi UV: inalterabile nel colore
UV-beständig: farbbeständig
résistant aux UV : inaltérabilité des couleurs
- **weather resistant (-30°C to +60°C)**
resistente al caldo e freddo (-30°C a +60°C)
wetterfest (-30°C bis +60°C)
résistant à la chaleur et au froid (-30 °C à +60 °C)
- **stackable**
impilabile
stapelbar
empilables
- **easy to wash without detergents**
lavabile senza detersivi
einfach ohne Reinigungsmittel waschbar
très facile à entretenir
- **anti-mould**
anti muffa
Anti-Schimmel
anti-moisissure
- **shock resistant**
resistente agli urti
stoß- und bruchfest
résistant aux chocs
- **lightweight**
leggerissimo
sehr leicht
très léger
- **the drainage hole allows excess water to leak from the pot**
foro predisposto
Wasseraustrittsloch vorhanden
trous de drainage prévus

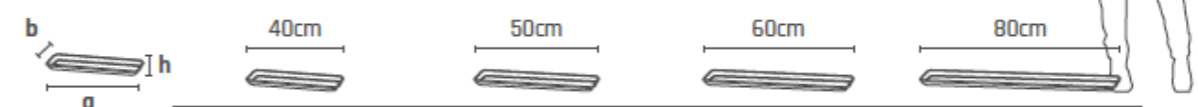

CODE	33 012 040 001 005 406	33 012 050 001 005 406	33 012 060 001 005 406	33 012 080 001 005 406
a cm / inches	40 / 15 ¾	50 / 19 ¾	60 / 22 ¾	80 / 31 ½
b h cm / inches	b = 19 / 7 ½ h = 3,2 / 1 ¼	b = 19 / 7 ½ h = 3,2 / 1 ¼	b = 19 / 7 ½ h = 3,2 / 1 ¼	b = 19 / 7 ½ h = 3,2 / 1 ¼
litres	2	3	5	8
minimum package (pcs)	10 38x19x10h 14x7½x3¾	10 48x19x10h 18½x7½x3¾	10 58x19x10h 22½x7½x3¾	10 78x19x10h 30½x7½x3¾



RE PEBBLES

Teraplast recycled plastic pebbles break new ground on the decorative front. Choose a new, environmentally friendly way to adorn your surroundings. RE PEBBLES in numerous different shapes and colours can give a fresh twist to pots and add a wonderful decorative touch to terraces, gardens and other settings.

IT

I ciottoli in plastica riciclata Teraplast tracciano nuove strade per le tue decorazioni. Scegli un nuovo modo per arredare i tuoi spazi, rispettando l'ambiente. I RE PEBBLES trasformano i tuoi vasi, arredano terrazzi, giardini e allestimenti con tante forme e colori diversi.

DE

Die Steine aus recyceltem Kunststoff von Teraplast weisen in Sachen Deko einen neuen Weg. Wählen Sie für Ihr Ambiente eine neue, umweltfreundliche Art der Ausstattung. Die RE PEBBLES verwandeln Ihre Pflanzgefäße, verschönern Terrassen, Gärten und Einrichtungen mit vielen verschiedenen Formen und Farben.

FR

Les cailloux en plastique recyclé Teraplast tracent de nouveaux chemins pour vos décorations. Choisissez un nouveau moyen de meubler vos espaces, tout en respectant l'environnement. Les RE PEBBLES transforment vos pots, ornent les terrasses, les jardins et les aménagements avec un large éventail de formes et de couleurs différentes.



DECORATE EVERY CORNER OF YOUR HOME AND GARDEN WITH THE FIVE NATURAL COLOURS, WHICH COME IN SMALL AND LARGE SIZES. ALL PEBBLES ARE UNIQUE PIECES IN COLOUR AND DERIVATION. THE DIFFERENT COLORING DEPENDS ON THE VARIETY OF RECYCLED PLASTIC MATERIAL USED FOR PRODUCTION.



IT

Cinque colorazioni naturali, disponibili in misure small e large, per aiutarti a decorare ogni angolo della tua casa e del tuo giardino. Tutti i Pebbles sono pezzi unici per colore e derivazione. La diversa colorazione dipende dalla varietà di plastica riciclata utilizzata.

DE

Fünf natürliche Farben, erhältlich in kleinen und großen Größen, die Ihnen helfen, jeden Winkel Ihres Hauses und Gartens zu dekorieren. Alle Dekosteine sind in Farbe und Herstellung ein Einzelstück. Die verschiedenen Nuancen hängen vom recycelten Kunststoffmix ab.

FR

Cinq coloris naturels, disponibles en petites et grandes dimensions, pour vous aider à embellir chaque recoin de votre maison et de votre jardin. Tous les galets sont des pièces uniques pour couleur et dérivation. La coloration différente dépend de la variété de plastique recyclé utilisé pour la production.



code 237

White

Bianco
Weiß
Blanc

code 238

Black

Nero
Schwarz
Noir



code 239

Green

Verde
Grün
Vert

code 240

Brown

Marrone
Braun
Marron

code 241

Grey

Grigio
Grau
Gris



**SMALL PEBBLES
IN FIVE BRIGHT COLOURS
TO BRIGHTEN UP AND
DECORATE EVERY CORNER
OF YOUR HOME AND
GARDEN.**



IT

Cinque colorazioni brillanti, disponibili nella misura small, che illumineranno e decoreranno ogni angolo della tua casa e del tuo giardino.

DE

Fünf leuchtende Farben, erhältlich in der Größe Small, die jeden Winkel Ihres Hauses und Ihres Gartens dekorieren und verschönern.

FR

Cinq coloris brillants, disponibles en petites dimensions, qui illumineront et enrichiront chaque recoin de votre maison et de votre jardin.

code 243

Gold

Oro

Gold

Or

code 245

Silver

Argento

Silber

Argent



code 247

Sapphire

Zaffiro

Saphirblau

Saphir

code 244

Ruby

Rubino

Rubinrot

Rubis

code 246

Emerald

Smeraldo

Smaragdgrün

Émeraude

PACKS

SMALL PEBBLES
surface covered

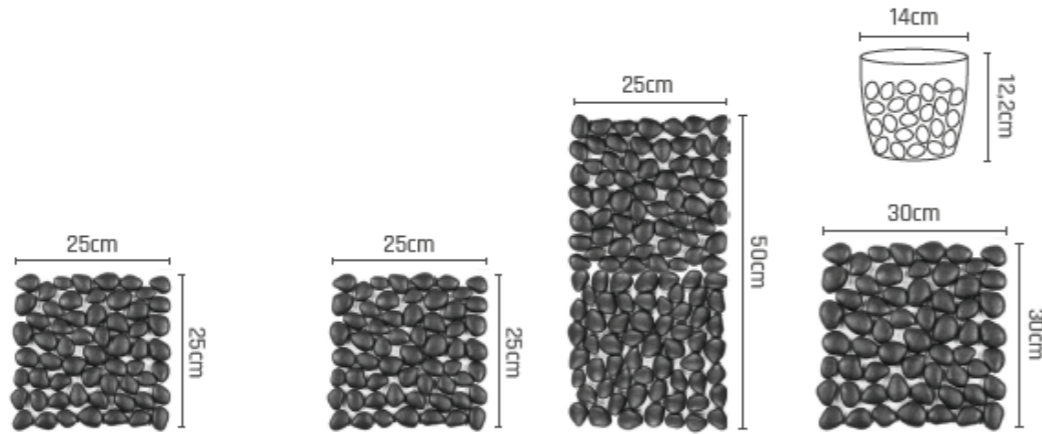
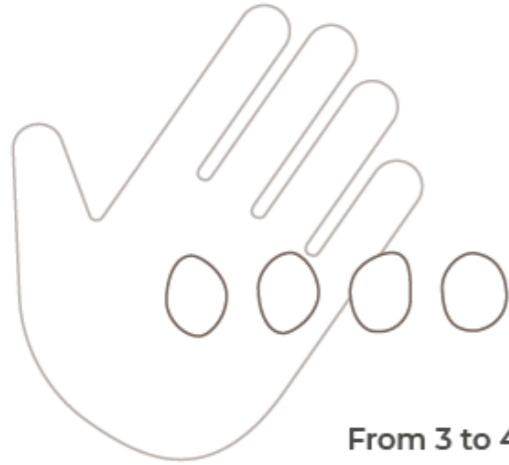

CODE	33 700 004 237 238 239 240 241		33 700 004 243 244 245 246 247		33 701 004 237 238 239 240 241		33 702 004 237 238 239 240 241 243 244 245 246 247		
size	SMALL		SMALL		SMALL		SMALL		
surface covered cm / inches	25x25 9 7/8x9 7/8		25x25 9 7/8x9 7/8		50x25 19 3/4x9 7/8		30x30 11 3/4x11 3/4		
m²	0,0625		0,0625		0,125		0,09		
minimum package	12 bags per box 28x14,5x33h 11x5 1/2x13	24 bags per display 26x26x33h 10 1/2x10 1/2x13	12 bags per box 28x14,5x33h 11x5 1/2x13	12 bags per display 26x30x32,5h 10 1/2x11 1/4x12 1/2	12 clear pots per display 30x30,5x41,5h 11 1/2x12x16 1/2				
pcs pallet	864 bags 80x120x115h 31 1/2x47 1/4x45 1/4				432 bags 80x120x115h 31 1/2x47 1/4x45 1/4		192 clear pots 80x120x95h 31 1/2x47 1/4x37 1/4		

PACKS

LARGE PEBBLES
surface covered

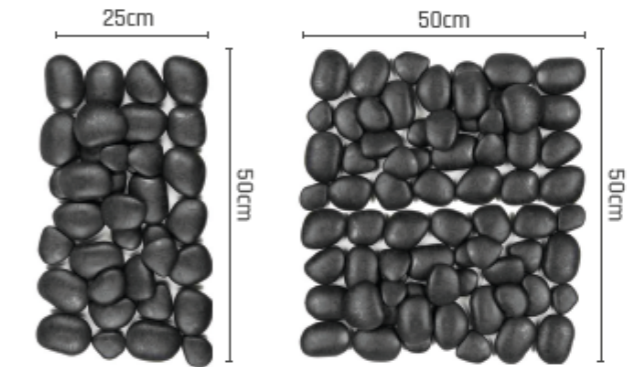

CODE	33 701 008 237 238 239 240 241					33 704 008 237 238 239 240 241				
size	LARGE					LARGE				
surface covered cm / inches	50x25 19 3/4x9 7/8					50x50 19 3/4x19 3/4				
m²	0,125					0,25				
minimum package	12 bags per display 28x26x39h 11x10 1/2x15 1/2					6 bags per display 37x26x33h 14 1/2x10 1/2x13				
pcs pallet	288 bags 80x120x95h 31 1/2x47 1/4x37 1/4					162 bags 80x120x115h 31 1/2x47 1/4x45 1/4				



TECH SPECS

-  - **lightweight**
 leggerissimo
 sehr leicht
 très léger

 - **ecological: non-toxic and recyclable**
 ecologica: atossico e riciclabile
 umweltfreundlich: nicht toxisch
 und recyclingfähig
 écologique : recyclable et non toxique

 - **odourless**
 inodori
 geruchsneutral
 inodores

 - **anti-mould**
 anti muffa
 Anti-Schimmel
 anti-moisissure

 - **easy to wash without detergents**
 lavabile senza detersivi
 einfach ohne Reinigungsmittel waschbar
 très facile à entretenir
-  - **decorative**
 decorativi
 dekorativ
 décoratifs

 - **versatile**
 versatili
 vielseitig
 polyvalents

 - **weather resistant (-30°C to +60°C)**
 resistente al caldo e freddo (-30°C a +60°C)
 wetterfest (-30°C bis +60°C)
 résistant à la chaleur et au froid (-30 °C à +60 °C)

 - **eco-friendly**
 eco friendly
 umweltfreundlich
 non pollutants

 - **UV resistant: colour-fast dyes**
 resistente ai raggi UV: inalterabile nel colore
 UV-beständig: farbbeständig
 résistant aux UV : inaltérabilité des couleurs

1
BOTTLE
OF WATER



= 1
RE PEBBLE



DISPLAY FOR RE-POT Cilindro AND RE-POT Sottovaso

5 SIZES AND 3 COLOURS

A practical, functional way to display the whole RE-POT Cilindro and RE-POT Sottovaso range in a small space.

Details of the sizes and amounts of RE-POT Cilindro and RE-POT Sottovaso that can be held by the display stand can be found below:

IT

Pratico e funzionale, in poco spazio si può esporre tutta la linea RE-POT Cilindro e RE-POT Sottovaso. L'espositore è adatto per contenere i nostri articoli RE-POT Cilindro e RE-POT Sottovaso nelle seguenti misure e quantità:

DE

Praktisch und funktional. Die gesamte RE-POT Cilindro und RE-POT Sottovaso Reihe kann platzsparend ausgestellt werden. Der Aufsteller eignet sich für die Aufnahme unserer RE-POT Cilindro und RE-POT Sottovaso Reihe mit folgenden Maßen und in der folgenden Anzahl:

FR

Pratique et fonctionnelle, vous pouvez exposer dans un petit espace toute la ligne RE-POT Cilindro et RE-POT Sottovaso. Le présentoir est apte à contenir nos articles RE-POT Cilindro et RE-POT Sottovaso dans les mesures et les quantités suivantes :



CODE WITHOUT COLOUR	33 001 020	33 001 025	33 001 030	33 001 035	33 001 040
∅ RE-POT Cilindro cm / inches	20 / 7 ¾	25 / 9 ¾	30 / 11 ¾	35 / 13 ¾	40 / 15 ¾
number of pieces displayed (per colour)	10	10	10	10	5

CODE WITHOUT COLOUR	33 011 018	33 011 022	33 011 026	33 011 030	33 011 035
∅ RE POT Sottovaso cm / inches	18 / 7 ¼	22 / 8 ¾	26 / 10 ¼	30 / 11 ¾	35 / 13 ¾
number of pieces displayed (per colour)	10	10	10	10	5

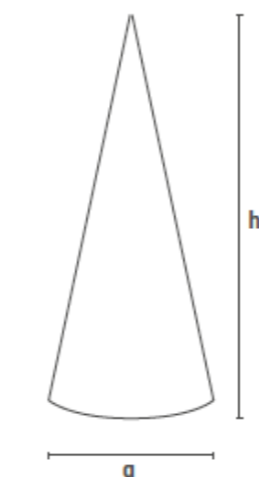

a = 120cm / 47 ¼ inches
h = 240cm / 94 ½ inches

DISPLAY FOR RE-POT Cassetta Mare AND RE-POT Sottocassetta Mare

4 SIZES AND 3 COLOURS

A practical, functional way to display the whole RE-POT Cassetta Mare and RE-POT Sottocassetta Mare range in a small space.

Details of the sizes and amounts of RE-POT Cassetta Mare and Sottocassetta Mare that can be held by the display stand can be found below:

IT

Pratico e funzionale, in poco spazio si può esporre tutta la linea RE-POT Cassetta Mare e RE-POT Sottocassetta Mare. L'espositore è adatto per contenere i nostri articoli RE-POT Cassetta Mare e RE-POT Sottocassetta Mare nelle seguenti misure e quantità:

DE

Praktisch und funktional. Die gesamte RE-POT Cassetta Mare und RE-POT Sottocassetta Mare Reihe kann platzsparend ausgestellt werden. Der Aufsteller eignet sich für die Aufnahme unserer RE-POT Cassetta Mare und RE-POT Sottocassetta Mare Reihe mit folgenden Maßen und in der folgenden Anzahl:

FR

Pratique et fonctionnelle, vous pouvez exposer dans un petit espace toute la ligne RE-POT Cassetta Mare et RE-POT Sottocassetta Mare. Le présentoir est apte à contenir nos articles RE-POT Cassetta Mare et RE-POT Sottocassetta Mare dans les mesures et les quantités suivantes :



CODE WITHOUT COLOUR	33 004 040	33 004 050	33 004 060	33 004 080
width RE-POT Cassetta Mare cm / inches	40 / 15 ¾	50 / 19 ¾	60 / 22 ¾	80 / 31 ½
number of pieces displayed (per colour)	5	5	5	5

CODE WITHOUT COLOUR	33 012 040	33 012 050	33 012 060	33 012 080
width RE POT Sottocassetta Mare cm / inches	40 / 15 ¾	50 / 19 ¾	60 / 22 ¾	80 / 31 ½
number of pieces displayed (per colour)	5	5	5	5

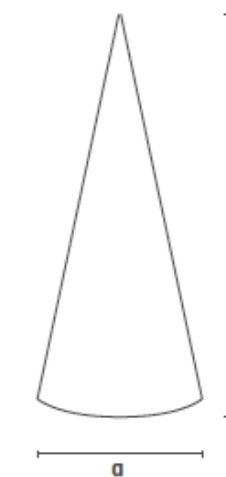

a = 140cm / 55 ¼ inches
h = 240cm / 94 ½ inches

**WOODEN DISPLAY
FOR LINEA RE**

Large
80x120x225 cm
31½x47¼x88⅝ inches



Small
60x80x225 cm
22⅝x31½x88⅝ inches



**PERSONAL COMPOSITION
BASED ON:**
- QUANTITY
- SIZE
- PRODUCT
- COLOUR

IT
composizione
a scelta per:
- misure
- quantità
- prodotto
- colore

DE
Zusammenstellung
wählbar nach:
- Maß
- Menge
- Produkt
- Farbe

FR
composition
au choix par :
- dimensions
- quantité
- produit
- couleur

BOX DISPLAY

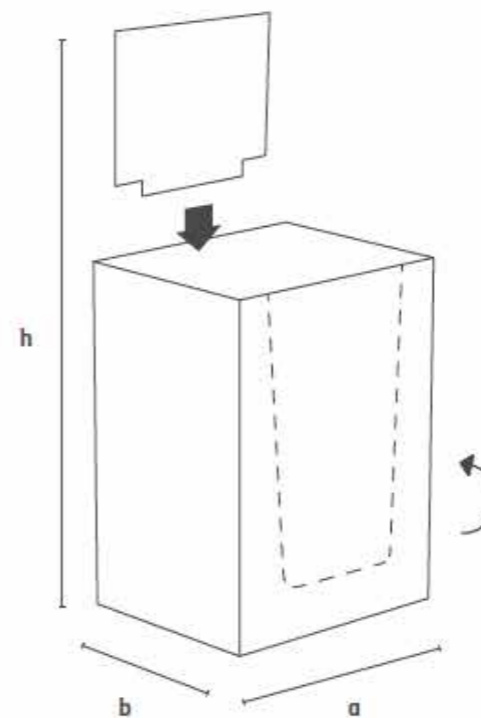

a = 26cm / 10¼ inches
b = 36cm / 14¼ inches
h = 51cm / 20¼ inches

Practical, functional counter displays.

IT
Proposti in pratico e funzionale display da banco.

DE
Als praktisches und funktionales Tischdisplay verfügbar.

FR
Proposés dans un présentoir de comptoir pratique et fonctionnel.

LABELLING



The new specific labels provide full details of the products in the Linea RE.

IT

Tutte le caratteristiche dei prodotti Linea RE sono contenute nelle nuove specifiche etichette.

DE

Alle Eigenschaften von Linea RE sind in den neuen Spezifikationen der Etiketten zu finden.

FR

Toutes les caractéristiques des produits de la ligne Linea RE se trouvent sur les nouvelles étiquettes spécifiques.



LABELLING



The new specific labels provide full details of the products in the Linea RE.

IT

Tutte le caratteristiche dei prodotti Linea RE sono contenute nelle nuove specifiche etichette.

DE

Alle Eigenschaften von Linea RE sind in den neuen Spezifikationen der Etiketten zu finden.

FR

Toutes les caractéristiques des produits de la ligne Linea RE se trouvent sur les nouvelles étiquettes spécifiques.

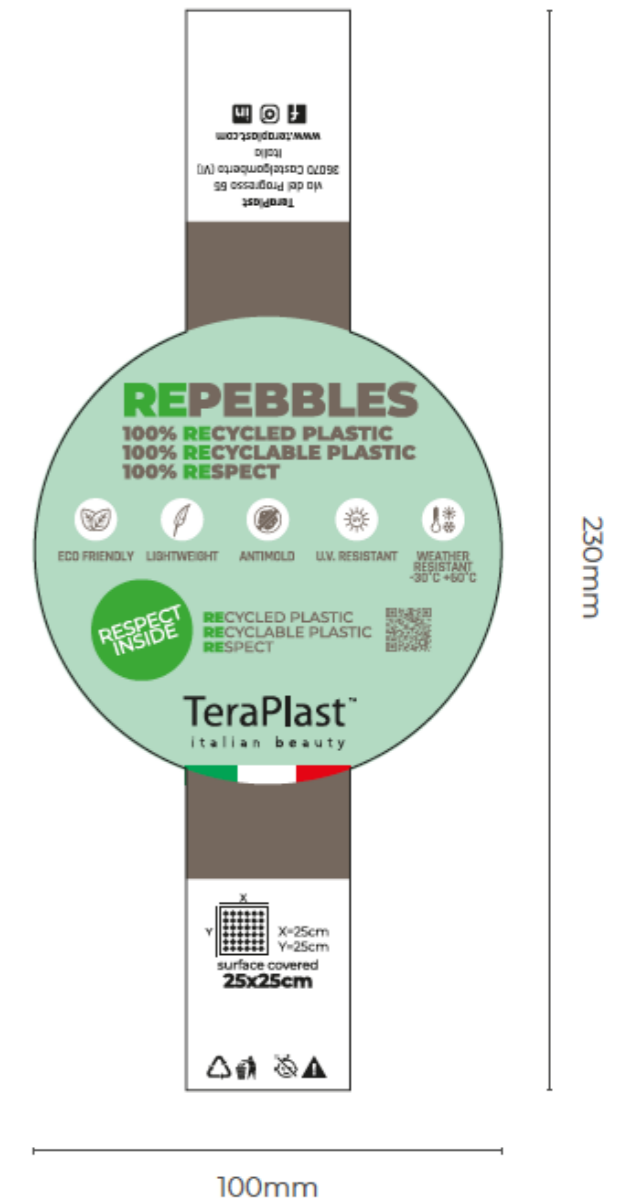

100mm

230mm

Customized indoor and outdoor services,
for products with a unique visual impact.

IT

Servizi personalizzati dall'indoor all'outdoor, per oggetti dall'impatto estetico unico.

DE

Maßgeschneiderte Angebote für Innen- und Außenbereiche: Artikel mit einer einzigartigen Ästhetik.

FR

Services personnalisés d'intérieur et d'extérieur pour des objets à l'impact esthétique unique.

Teraplast stands out thanks to its flexibility, range of products and innovative capabilities. It makes items with injection and rotational moulding technology and provides customized services such as bespoke mould production, processing, colouring, assembly and packaging. Pots and all other designer creations are conceived to combine aesthetic appeal and practical solutions that are suitable for use both indoors and outdoors. In the field of plastic processing and moulding, Teraplast products embody the exceptional qualities associated with the "Made in Italy" label. Furthermore, Teraplast has always placed great importance on environmental initiatives. It has a modern photovoltaic system that produces 32% of the energy needed to process its raw materials.

IT

Teraplast si distingue per flessibilità, gamma prodotti e capacità di innovazione. Produce articoli con tecnologia a iniezione e rotazionale, fornendo servizi personalizzati come la realizzazione di stampi, lavorazioni, colorazioni, assemblaggi e imballi su misura. Che si tratti di un vaso o di un oggetto di design, i prodotti sono concepiti coniugando esigenze estetiche e funzionali sia per ambienti indoor che outdoor. I prodotti Teraplast rappresentano l'eccellenza del "Made in Italy" nel campo della lavorazione e dello stampaggio delle materie plastiche. Da sempre sensibile alle iniziative ambientali, grazie a un moderno impianto fotovoltaico Teraplast produce il 32% dell'energia che serve per la trasformazione della materia prima.

DE

Teraplast zeichnet sich durch Flexibilität, Produktvielfalt und Innovationsfähigkeit aus. Die Herstellung der Artikel erfolgt mit Spritzguss- und Rotationstechnik und ermöglicht maßgeschneiderte Angebote, wie Formenherstellung, Verarbeitungen, Färbung, Montage und Verpackungen nach Maß. Ob Pflanzgefäß oder Designobjekt: Die Produkte sind so konzipiert, dass sie den ästhetischen und funktionalen Anforderungen für Innen- und Außenbereiche gerecht werden. Im Bereich der Verarbeitung und Formgebung von Kunststoffen stehen die Produkte von Teraplast für Spitzenqualität „Made in Italy“. Dank einer modernen Photovoltaikanlage produziert Teraplast 32 % der für die Umwandlung des Rohstoffs benötigten Energie, was der seit jeher bestehenden umweltfreundlichen Ausrichtung des Unternehmens entspricht.

FR

Teraplast se distingue par sa flexibilité, sa gamme de produits et sa capacité à innover. Nous fabriquons des articles avec la technologie d'injection et de rotation, offrant des services personnalisés, comme la réalisation de moules, de traitements, de coloris, d'assemblages et d'emballages sur mesure. Qu'il s'agisse d'un pot ou d'un objet design, les produits sont conçus en conjuguant les exigences esthétiques et fonctionnelles des atmosphères intérieures comme extérieures. Les produits Teraplast représentent l'excellence du « Made in Italy » dans le domaine du traitement et du moulage des matières plastiques. Depuis toujours sensible aux initiatives environnementales, grâce à son installation photovoltaïque moderne, l'entreprise Teraplast produit 32 % de l'énergie qu'elle utilise pour transformer la matière première.

Intro Self Watering



Riserva d'acqua

La riserva d'acqua permette di alimentare le vostre piante senza bisogno di irrigarle spesso. I fori di drenaggio permettono di scaricare eventuali eccessi d'acqua, così sarà la pianta stessa ad attingere alla riserva quando ne avrà bisogno.

Alcuni vasi dotati di questo sistema presentano anche una membrana di rivestimento che, una volta rimossa, permette all'acqua in eccesso di fuoriuscire dal vaso.

Self-watering system

The self-watering system allows you to cater to your plants' needs without having to water them too often. The drainage holes let out any excess water, so that the plant itself can draw on the contents of the reservoir when it needs them.

Some of the pots equipped with this system also have a coating membrane that can be removed to let excess water leak out.

Réserve d'eau

La réserve d'eau permet d'alimenter vos plantes sans devoir les arroser souvent. Les trous de drainage vous permettent d'évacuer toute l'eau en excès de sorte que la plante puisera elle-même dans la réserve d'eau selon ses besoins.

Certains des pots équipés de ce système disposent également d'une membrane de revêtement qui, une fois retirée, permet à l'excès d'eau de s'évacuer.

Wasserspeicher

Der Wasserspeicher ermöglicht es Ihnen, Ihre Pflanzen zu versorgen, ohne sie häufig bewässern zu müssen. Durch die Entwässerungslöcher wird überschüssiges Wasser abgeleitet, sodass die Pflanze selbst bei Bedarf aus dem Wasservorrat schöpft.

Einige der mit diesem System ausgestatteten Pflanzgefäße sind auch mit einer Beschichtung versehen. Wird diese entfernt, kann überschüssiges Wasser aus dem Topf entweichen.

diffusione dell'acqua
per osmosi
water diffusion through
osmosis's effect
diffusion de l'eau par
osmose
Wasserdiffusion durch
Osmose

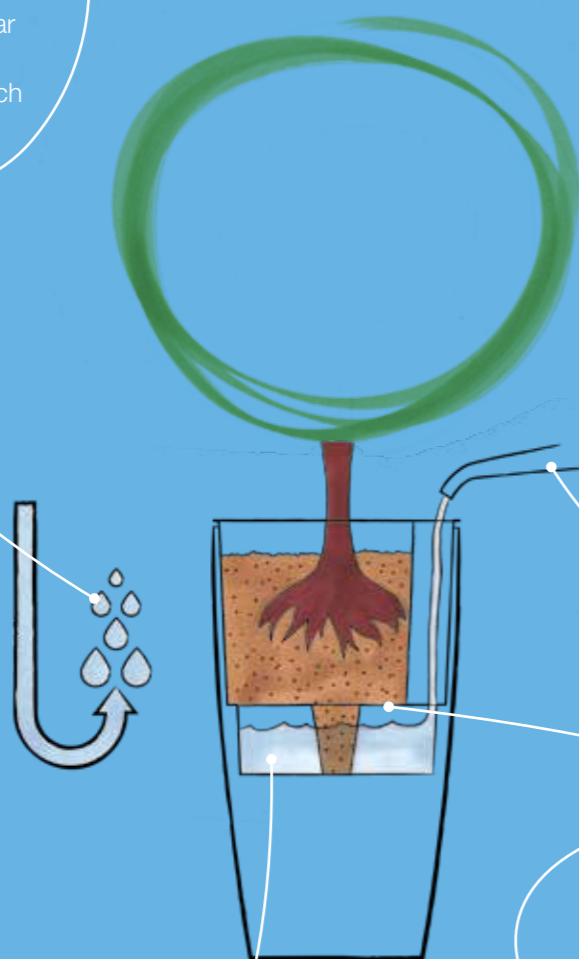

beccuccio per
inserimento dell'acqua
spout for water
insertion
bec pour l'introduction
de l'eau
Füllschacht zur
Wasserversorgung

griglia di drenaggio
drainage grid
gril pour le drainage
Bewässerungseinsatz

riserva d'acqua
Self-watering system
réserve d'eau
Wasserspeicher

Interessante? Gira
pagina e scopri
tutti!

Interesting, isn't it?
Go and find more!

Intéressant?
Blättern Sie weiter
und entdecken Sie
mehr!

Intéressant?
Tournez la page
pour en savoir plus!



Re-Pots Hoop
pagina 18



Stem
pagina 54



Stalk
pagina 56



Air
pagina 62



Hydral
pagina 64



Still
pagina 70



Aqua
pagina 72

Intro Self Watering



Molti dei nostri vasi sono dotati di **riserva d'acqua**. Scopri i dettagli nelle pagine dedicate.

Most of our pots are provided with **water reserve** system. Find more details on the related pages.

Plusieurs de nos pots sont équipés de **réserve d'eau**. Découvrez les détails dans les pages dédiées.

Wir bieten viele Blumenkästen mit **Bewässerungssystem** an. Entdecken Sie die Details auf die entsprechenden Seiten.



Estoril
pagina 124



Algarve
pagina 130



Cassetta Portofino
pagina 162



Cassetta Coste
pagina 164



Divio
pagina 217



Schio Cassa
pagina 232



Schio Cubo
pagina 235



linea
ELEMENTS



Stem



Stalk

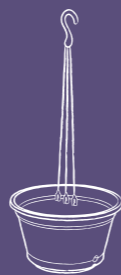

Air



Hydral



kit balcone
Hydral



Still

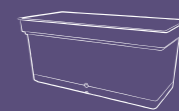

Aqua



Basilio

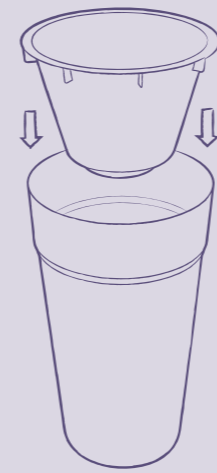

Riserva d'acqua
Self-watering system
Réserve d'eau
Wasserspeicher

diffusione dell'acqua per osmosi
water diffusion through osmosis's effect
diffusion de l'eau par osmose
Wasserdiffusion durch Osmose

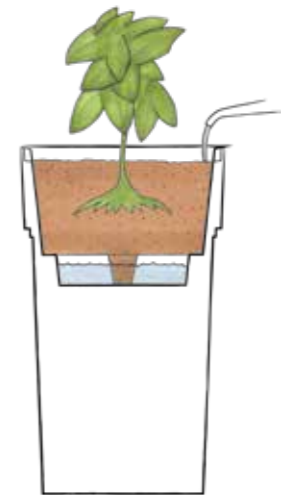

022
bianco/white
blanc/weiß



414
fog grey/ fog grey
brouillard gris/Nebel grau



406
bruno/brown
brun/braun



404
cedro/cedar
cèdre/zeder



005
antracite/anthracite
anthracite/anthrazitgrau

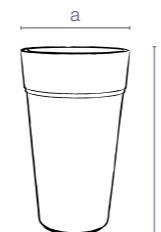

codice senza colore code without colour	Cm	dimensioni dimensions	litri liters	Confezione minima Minimum package	m ³	pezzi pallet pcs pallet	m ³
28 124 065	65	a38 b65	14	5 39x39x106h	0,16	96 80x115x227h	2,1
28 124 080	80	a38 b80	14	4 39x39x109h	0,17	60 80x115x233h	2,1



Stem

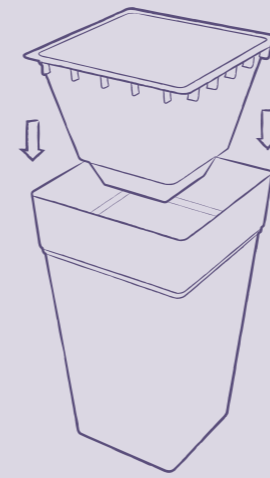

Riserva d'acqua
Self-watering system
Réserve d'eau
Wasserspeicher

diffusione dell'acqua per osmosi
water diffusion through osmosis's effect
diffusion de l'eau par osmose
Wasserdiffusion durch Osmose

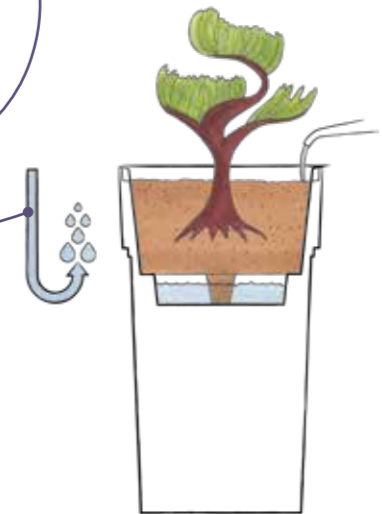

022
bianco/white
blanc/weiß



414
fog grey/ fog grey
brouillard gris/Nebel grau



406
bruno/brown
brun/braun

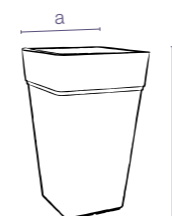

codice senza colore code without colour	Cm	dimensioni dimensions	litri liters	Confezione minima Minimum package	m ³	pezzi pallet pcs pallet	m ³
28 123 065	022 414 406	65	a38 b65 21	5 39x39x106h	0,16	60 80x115x227h	2,1
28 123 080	022 414 406	80	a38 b80 21	4 39x39x109h	0,18	48 80x115x233h	2,1



Stalk



404
cedro/cedar
cèdre/zeder



005
antracite/anthracite
anthracite/anthrazitgrau

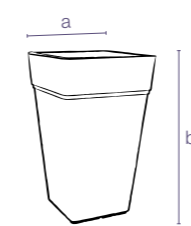

codice senza colore code without colour	Cm	dimensioni dimensions	litri liters	Confezione minima Minimum package	pezzi pallet pcs pallet	m ³
28 123 065	404 005	65	a38 b65 21	5 39x39x106h	0,16	60 80x115x227h 2,1
28 123 080	404 005	80	a38 b80 21	4 39x39x109h	0,18	48 80x115x233h 2,1



caratteristiche lampada: attacco E27, tensione max 220, potenza max 11 W, tipo risp. energ. standard

lamp characteristics: electrical coupling E27, max voltage 220, max electrical power 11 W, standard energy saving type lamp

caractéristiques de l'ampoule: culot E27, tension max 220, puissance max 11W, type économie d'énergie standard

charakteristik der Lampe E27 Fassung, max. 220 Volt max. 11 W. Energiesparlampe Typ Standard



codice senza colore code without colour	Cm	dimensioni dimensions	litri liters	Confezione minima Minimum package	m ³	pezzi pallet pcs pallet	m ³
32 124 065	65	a38 b65	14	2 40x40x106h	0,17	24 80x115x230h	2,1
32 124 080	80	a38 b80	14	2 40x40x112h	0,18	24 80x115x230h	2,1



codice senza colore code without colour	Cm	dimensioni dimensions	litri liters	Confezione minima Minimum package	m ³	pezzi pallet pcs pallet	m ³
32 123 065	65	a38 b65	21	2 40x40x106h	0,17	24 80x120x229h	2,1
32 123 080	80	a38 b80	21	2 40x40x112h	0,18	24 80x120x240h	2,3

Stem e Stalk luce





Gancio incluso
Hook included
Crochet Inclus
Einschließlich Haken

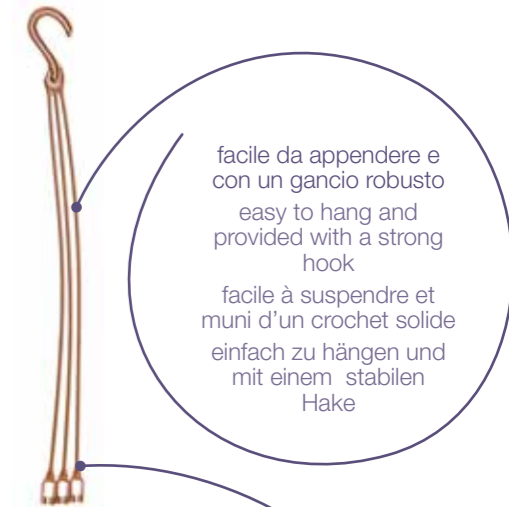

facile da appendere e con un gancio robusto
easy to hang and provided with a strong hook
facile à suspendre et muni d'un crochet solide
einfach zu hängen und mit einem stabilen Hake

codice: 03 308 050
I ganci sono disponibili anche sfusi in mazzetti da 12
Hooks are also available in packs with 12 pcs
Les crochets sont aussi disponibles dans emballages de 12 pièces
Die Haken sind los in VE von 12 Stk verfügbar



022
bianco/white
blanc/weiß



404
cedro/cedar
cèdre/zeder



406
bruno/brown
brun/braun



001
terracotta/terracotta colour
couleur terre/farbe terrakotta



005
antracite/anthracite
anthracite/anthrazitgrau

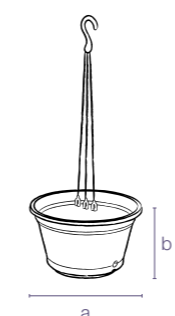

codice senza colore code without colour	Cm	dimensioni dimensions	litri liters	Confezione minima Minimum package	m ³	pezzi pallet pcs pallet	m ³			
28 125 029	022, 404, 406, 001, 005	65	a28,5 b17	6,3	12	29x29x50h	0,04	264	80x115x115h	1,058

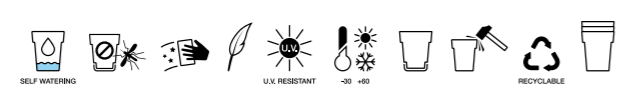

Air

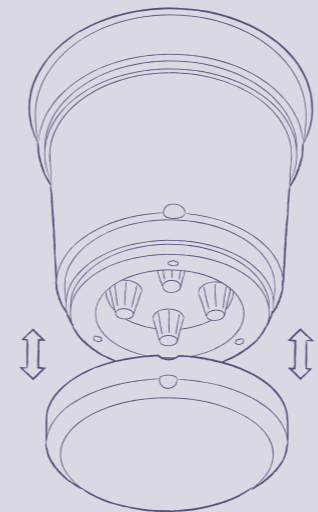

Il sottovaso è incluso e viene fissato ad incastro.
 The saucer is included and is fitted into.
 La soucoupe est inclus et est emboîtée dans.
 Der Untersetzer ist eingeschlossen und mit Clip-Funktion zusammengesteckt.

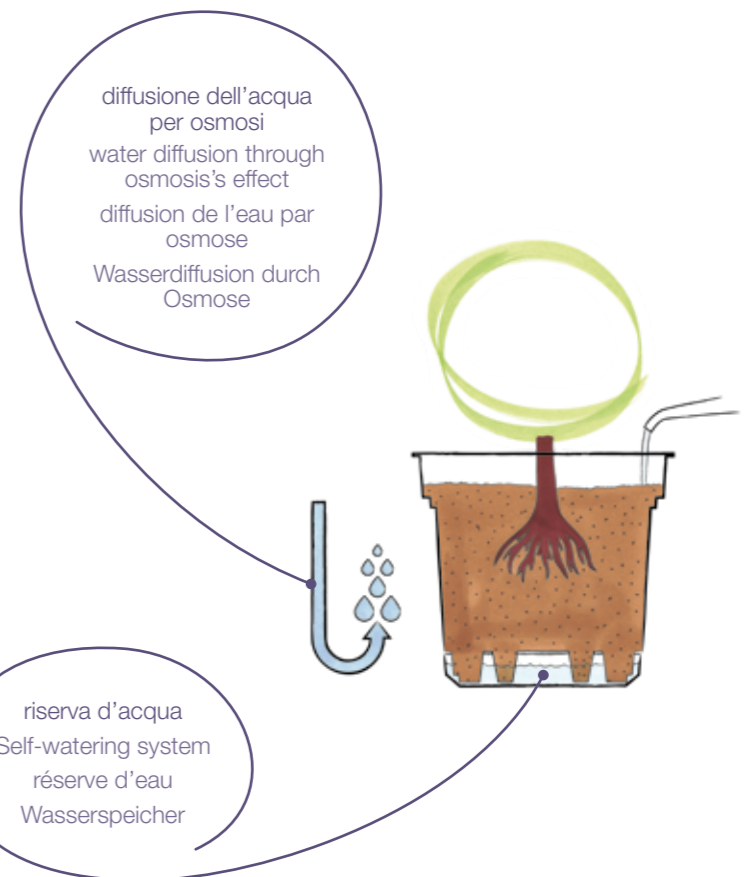

005
 antracite/anthracite
 anthracite/anthrazitgrau



001
 terracotta/terracotta colour
 couleur terre/farbe terrakotta

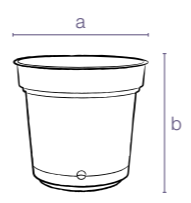

codice senza colore code without colour	Cm	dimensioni dimensions	litri liters	Confezione minima Minimum package	pezzi pallet pcs pallet	m ³
28 107 018	005 001	18	a18 b16 2,5	20 18x18x33h	0,008	960
28 107 023	005 001	23	a23 b21 5	10 23x23x43h	0,030	540
28 107 028	005 001	28	a28 b25 9,3	10 28x28x48h	0,030	330
28 107 033	005 001	33	a33 b30 15,3	10 33x33x43h	0,037	140
28 107 038	005 001	38	a38 b34 23	8 38x38x68h	0,077	96
28 107 048	005 001	48	a48 b43 46,5	4 48x48x58h	0,105	144
28 107 058	005 001	58	a58 b48 77	4 58x58x68h	0,180	96
28 107 068	005 001	68	a68 b55 120	2 68x68x60h	0,218	26
28 107 078	005 001	78	a78 b61 175,5	2 78x78x65h	0,310	22

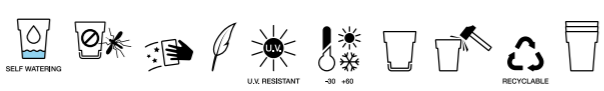

Hydral

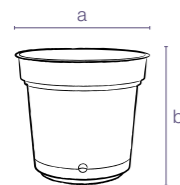

codice senza colore code without colour	Cm	dimensioni dimensions	litri liters	Confezione minima Minimum package	pezzi pallet pcs pallet	m ³
28 107 018	18	a18 b16	2,5	20 18x18x33h	0,008	960 80x115x115h 1,06
28 107 023	23	a23 b21	5	10 23x23x43h	0,030	540 80x115x115h 1,06
28 107 028	28	a28 b25	9,3	10 28x28x48h	0,030	330 80x115x115h 1,06
28 107 033	33	a33 b30	15,3	10 33x33x43h	0,037	140 80x120x120h 1,32
28 107 038	38	a38 b34	23	8 38x38x68h	0,077	96 80x115x115h 1,06
28 107 048	48	a48 b43	46,5	4 48x48x58h	0,105	144 100x115x230h 2,65
28 107 058	58	a58 b48	77	4 58x58x68h	0,180	96 100x115x230h 2,12
28 107 068	68	a68 b55	120	2 68x68x60h	0,218	26 78x78x230h 1,40
28 107 078	78	a78 b61	175,5	2 78x78x65h	0,310	22 78x78x230h 1,40



404
cedro/cedar
cèdre/zeder



022
bianco/white
blanc/weiß



“Cercavo un vaso di buone dimensioni dove trapiantare i pomodori. Il materiale è resistente ed è comodo il sottovaso integrato. Consiglio di mettere dell'argilla espansa sul fondo per migliorare il drenaggio dell'acqua in eccesso.”

“I was looking for a pot with good dimensions to transplant the tomatoes. The material is resistant and the integrated saucer is smart. My advice is to fill the pot with some clay pebbles to improve the drainage of the excess water.”

“Ich suchte einen großen Topf um Tomaten zu pflanzen. Das Material ist hier beständig und der integrierte Untersetzer ist praktisch. Für eine gute Drainage empfehle ich den Topfboden mit einer Blähton-schicht zu füllen.”

“Je cherchais un grand pot pour planter des tomates. Là le matériel est durable et la soucoupe intégrée est pratique. Pour le drainage de l'eau en excès je conseille de mettre de l'argile expansée sur le fond du pot.”

Sara



414

fog grey/ fog grey
brouillard gris/Nebel grau



406

bruno/brown
brun/braun

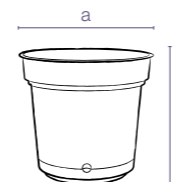

codice senza colore code without colour	Cm	dimensioni dimensions	litri liters	Confezione minima Minimum package	m ³	pezzi pallet pcs pallet	m ³
28 107 018	414/406	18	a18 b16 2,5	20 18x18x33h	0,008	960 80x115x115h	1,06
28 107 023	414/406	23	a23 b21 5	10 23x23x43h	0,030	540 80x115x115h	1,06
28 107 028	414/406	28	a28 b25 9,3	10 28x28x48h	0,030	330 80x115x115h	1,06
28 107 033	414/406	33	a33 b30 15,3	10 33x33x43h	0,037	140 80x120x120h	1,32
28 107 038	414/406	38	a38 b34 23	8 38x38x68h	0,077	96 80x115x115h	1,06
28 107 048	414/406	48	a48 b43 46,5	4 48x48x58h	0,105	144 100x115x230h	2,65
28 107 058	414/406	58	a58 b48 77	4 58x58x68h	0,180	96 100x115x230h	2,12
28 107 068	414/406	68	a68 b55 120	2 68x68x60h	0,218	26 78x78x230h	1,40
28 107 078	414/406	78	a78 b61 175,5	2 78x78x65h	0,310	22 78x78x230h	1,40

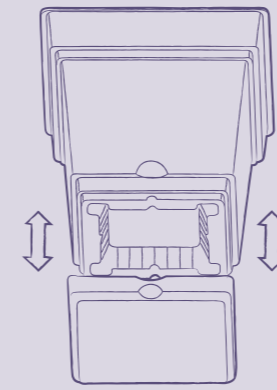

Il sottovaso è incluso e viene fissato ad incastro.
The saucer is included and is fitted into.
La soucoupe est inclus et est emboîtée dans.
Der Untersetzer ist eingeschlossen und mit Clip-Funktion zusammengesteckt.

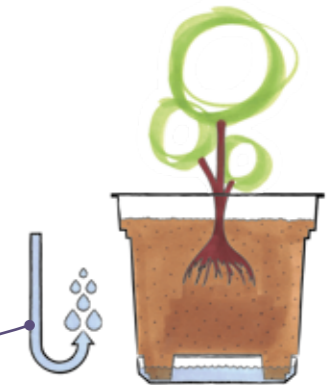
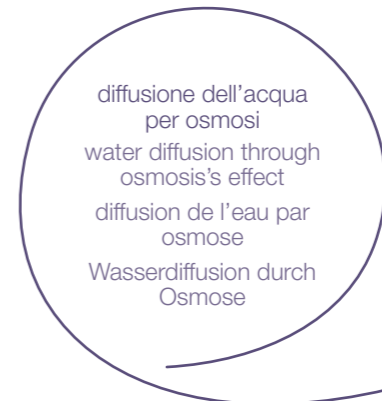

022
bianco/white
blanc/weiß



414
fog grey/ fog grey
brouillard gris/Nebel grau



406
bruno/brown
brun/braun



001
terracotta/terracotta colour
couleur terre/farbe terrakotta



404
cedro/cedar
cèdre/zeder



005
antracite/anthracite
anthracite/anthrazitgrau

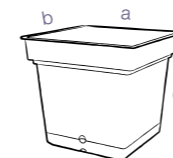

codice senza colore code without colour	Cm	dimensioni dimensions	litri liters	Confezione minima Minimum package	m ³	pezzi pallet pcs pallet	m ³			
28 111 038	022 414 406 001 404 005	38	a:38 b:38 c:38	29	4	38x38x47h	0,068	96	80x115x115h	1,06
28 111 047	022 414 406 001 404 005	47	a:47 b:47 c:47	55	4	47x47x59h	0,130	128	100x115x230h	2,65

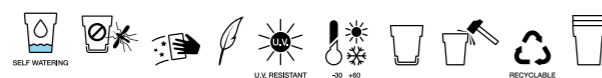

Still

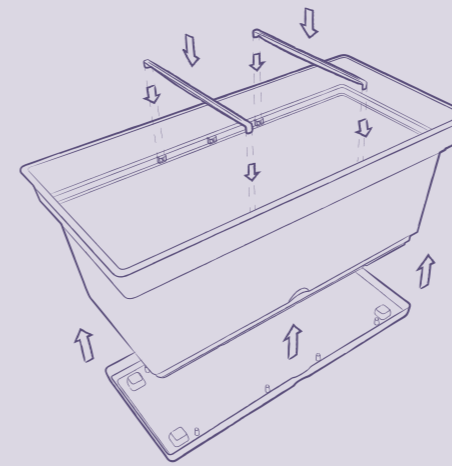

Il sottovaso e i distanziali sono inclusi e vengono fissati ad incastro.

The saucer and the brackets are included and are fitted into.

Der Untersetzer und die Distanzhalter sind eingeschlossen und mit Clip-Funktion zusammenbefestigt

La soucoupe et les espaceurs sont inclus et emboîtés

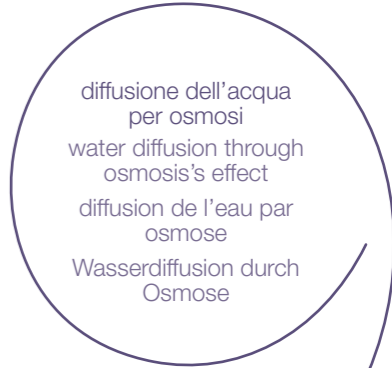

diffusione dell'acqua per osmosi
water diffusion through osmosis's effect
diffusion de l'eau par osmose
Wasserdiffusion durch Osmose

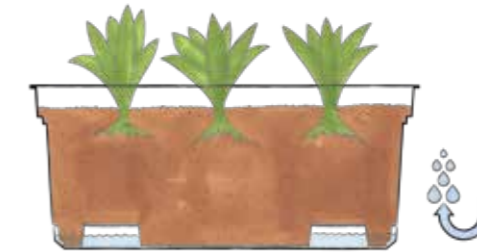

022

bianco/white
blanc/weiß



414

fog grey/ fog grey
brouillard gris/Nebel grau



406

bruno/brown
brun/braun



001

terracotta/terracotta colour
couleur terre/farbe terrakotta



404

cedro/cedar
cèdre/zeder



005

antracite/anthracite
anthracite/anthrazitgrau

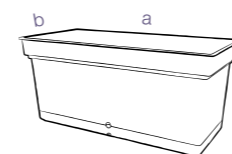

codice senza colore
code without colour

28 109 078

28 109 098

		Cm	dimensioni dimensions	litri liters	Confezione minima Minimum package	m ³	pezzi pallet pcs pallet	m ³
	022 414 406 001 404 005	78	a78 b38 c38	66	4 78x38x47h	0,139	120 80x115x230h	2,12
	022 414 406 001 404 005	98	a99 b47 c47	130	4 98x47x59h	0,272	64 100x115x230	2,65



Aqua



grow
your own
veggies
at home!

Crea il tuo orto urbano abbinando il supporto Basilio ai vasi Aqua e Still

Create your urban garden combining the support Basilio with the pots Aqua and Still
Créez votre potager en hauteur avec le support Basilio et les pot Aqua et Still
Bau dein Hochbeet mit der Halterung Basilio und den Töpfen Aqua und Still

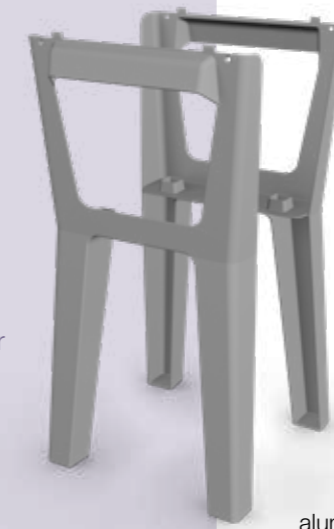

Design by:
favaretto/partners

417

aluminium/aluminium
aluminium/aluminium

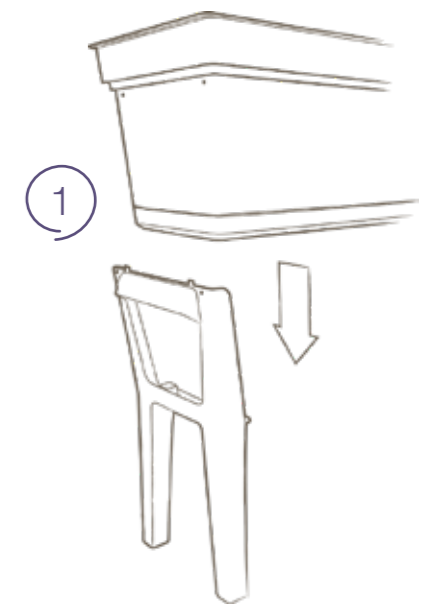

Still cm 38
pagina 68



Aqua cm 78
pagina 70

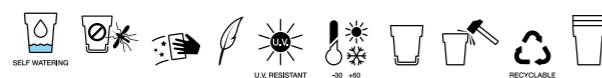
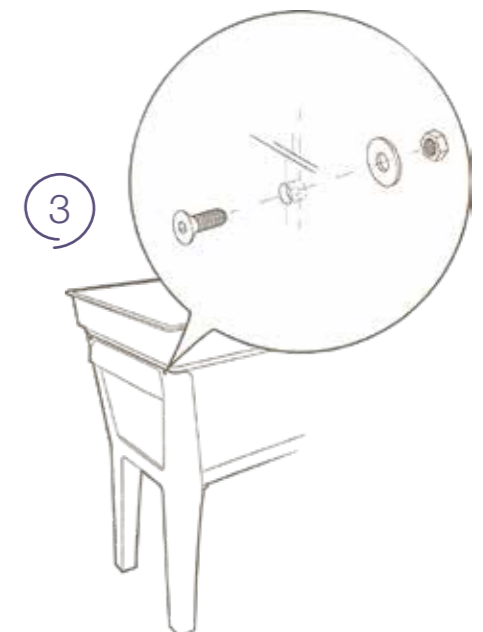
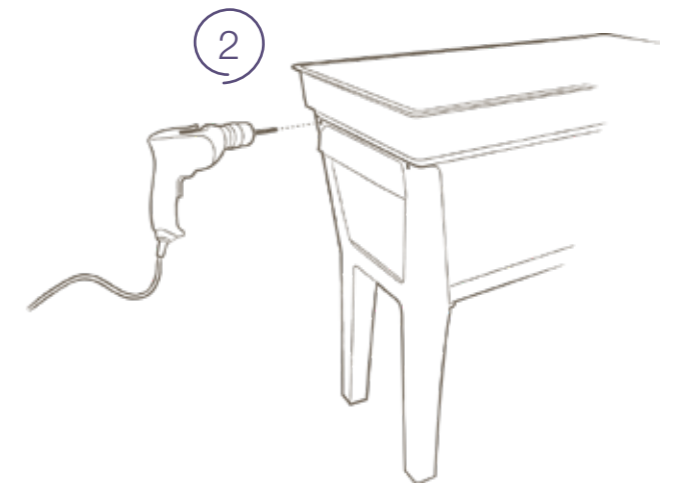

Basilio



codice senza colore code without colour	Cm	dimensioni dimensions	Confezione minima Minimum package	pezzi pallet pcs pallet
28 113 061	61	a61 b32	1 65x35x20h	39 80x120x230h

Consigli utili

Basilio permette di prendervi cura delle vostre piante, fiori e ortaggi più comodamente.

- La scelta del terriccio è determinante per il successo del tuo orto, fatti consigliare dal rivenditore locale o l'agricoltore vicino.
- Scegli il posto giusto per il tuo basilio, considerando che l'esposizione a sud è quella ottimale.
- Semina seguendo le indicazioni di spazio e profondità indicate sulla confezione dei semi, oppure scegli delle piantine già cresciute per semplificare il lavoro.
- Annaffia le piante al tramonto o al mattino presto.
- Alcuni ortaggi producono di più se vengono raccolti spesso come fagioli, zucchine, peperoni e cetrioli.

Useful advice

Basilio allows to look after of your plants, flowers and veggies more easily.

- Soil is essential for the success of your urban garden; ask the retailer or the nearby agriculturist for a suggestion.
- Choose the best place for your Basilio, considering that facing south is the best position.
- Sow following the advice indicated on the packaging, or choose the seedlings to simplify the work.
- Water the plants at sunset or early in the morning.
- Some vegetables as beans, zucchini, peppers and cucumbers are more productive if they are harvested often.



Conseils

Basilio peut prendre soin de vos plantes, vos fleurs et vos légumes plus facilement.

- Le choix de la terre est décisif pour le succès de votre potager, faites-vous conseiller par votre commerçant ou par l'agriculteur local.
- Choisissez la bonne place pour votre Basilio, considérant que l'exposition au sud est optimale.
- Semez en suivant les indications de distance et profondeur indiquées sur l'emballage des graines ou choisissez les plants déjà développés afin de simplifier le travail.
- Arrosez les plantes le soir ou tôt le matin.
- Certains légumes produisent plus s'ils sont cueillis souvent comme les haricots, les courgettes, les poivrons et les concombres.

Empfehlungen

Basilio macht Ihre Pflege für Pflanzen, Blumen und Gemüse bequemer.

- Die richtige Gartenerde ist für den Erfolg Ihres Hochbeetes grundsätzlich, lassen Sie sich von Ihrem Fachhändler beraten.
- Wählen Sie für Ihr Basilio den richtigen Standort. Eine Ausrichtung nach Süden wäre optimal.
- Beachten Sie bei der Aussaat den Abstand und die Tiefe die auf den Samentütchen angegeben sind. Um die Arbeit zu vereinfachen können Sie auch vorkultivierte Pflanzen wählen.
- Begießen Sie die Pflanzen abends oder am frühen Morgen.
- Einige Gemüse, wie z.B. Bohnen, Zucchini, Paprika und Gurken, erzeugen mehr, wenn man sie häufig erntet.





kit balcone Hydral



022
bianco/white
blanc/weiß



414
fog grey/ fog grey
brouillard gris/Nebel grau



406
bruno/brown
brun/braun



001
terracotta/terracotta colour
couleur terre/farbe terrakotta



404
cedro/cedar
cèdre/zeder



005
antracite/anthracite
anthracite/anthrazitgrau

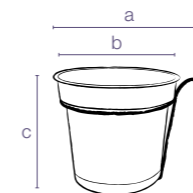

codice senza colore code without colour	Cm	dimensioni dimensions	pezzi pallet pcs pallet	m ³
28 130 023	23	a30 b23 c21	15 60x40x52h	0,13
			88 60x80x115h	0,55



linea
TERAGUARD



Hydral
Teraguard



Hydral kit balcone
Teraguard



Air
Teraguard



Still
Teraguard



Aqua
Teraguard

news
2019



Evita l'annidamento di zanzare e altri insetti.

It stops mosquitoes and other insects from laying eggs.

Évite la nidation des moustiques et autres insectes.

Das Einnisten von Mücken und anderen Insekten wird verhindert.



022

bianco/white
blanc/weiß



414

fog grey/ fog grey
brouillard gris/Nebel grau



406

bruno/brown
brun/braun



001

terracotta/terracotta colour
couleur terre/farbe terrakotta



404

cedro/cedar
cèdre/zeder



005

antracite/anthracite
anthracite/anthrazitgrau

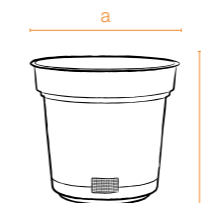

codice senza colore code without colour	Cm	dimensioni dimensions	litri liters	Confezione minima Minimum package	m ³	pezzi pallet pcs pallet	m ³
34 107 018	18	a18 b16	2,5	20 18x18x33h	0,008	960 80x115x115h	1,06
34 107 023	23	a23 b21	5	10 23x23x43h	0,030	540 80x115x115h	1,06
34 107 028	28	a28 b25	9,3	10 28x28x48h	0,030	330 80x115x115h	1,06
34 107 033	33	a33 b30	15,3	10 33x33x43h	0,037	140 80x120x120h	1,32
34 107 038	38	a38 b34	23	8 38x38x68h	0,077	96 80x115x115h	1,06
34 107 048	48	a48 b43	46,5	4 48x48x58h	0,105	144 100x115x230h	2,65
34 107 058	58	a58 b48	77	4 58x58x68h	0,180	96 100x115x230h	2,12
34 107 068	68	a68 b55	120	2 68x68x60h	0,218	26 78x78x230h	1,40
34 107 078	78	a78 b61	175,5	2 78x78x65h	0,310	22 78x78x230h	1,40



Hydral
Teraguard



Hydral kit balcone Teraguard

Air Teraguard

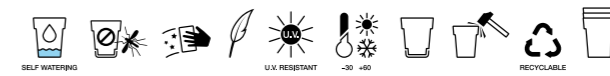

022
bianco/white
blanc/weiß



414
fog grey/ fog grey
brouillard gris/Nebel grau



406
bruno/brown
brun/braun



001
terracotta/terracotta colour
couleur terre/farbe terrakotta



404
cedro/cedar
cèdre/zeder



005
antracite/anthracite
anthracite/anthrazitgrau

Gancio incluso
Hook included
Crochet Inclus
Einschließlich Haken

facile da appendere e con un gancio robusto
easy to hang and provided with a strong hook
facile à suspendre et muni d'un crochet solide
einfach zu hängen und mit einem stabilen Hake

codice: 03 308 050
I ganci sono disponibili anche sfusi in mazzetti da 12
Hooks are also available in packs with 12 pcs
Les crochets sont aussi disponibles dans emballages de 12 pièces
Die Haken sind los in VE von 12 Stk verfügbar



022
bianco/white
blanc/weiß



404
cedro/cedar
cèdre/zeder



406
bruno/brown
brun/braun



001
terracotta/terracotta colour
couleur terre/farbe terrakotta



005
antracite/anthracite
anthracite/anthrazitgrau

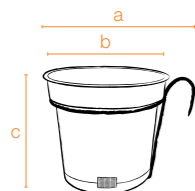

codice senza colore code without colour	Cm	dimensioni dimensions	pezzi pallet pcs pallet	m ³
34 130 023	23	a30 b23 c21	15	60x40x52h 0,13
			88	60x80x115h 0,55

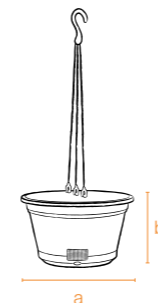

codice senza colore code without colour	Cm	dimensioni dimensions	litri liters	Confezione minima Minimum package	m ³	pezzi pallet pcs pallet	m ³
34 125 029 022 404 406 001 005	29	a28,5 b17	6,3	12	29x29x50h 0,04	264	80x115x115h 1,058

news
2019



diffusione dell'acqua per osmosi
water diffusion through osmosis's effect
diffusion de l'eau par osmose
Wasserdiffusion durch Osmose

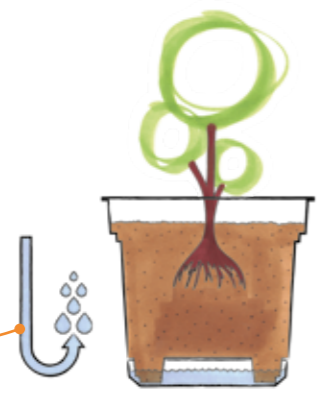

Still Teraguard

Il sottovaso è incluso e viene fissato ad incastro.
The saucer is included and is fitted into.
La soucoupe est inclus et est emboîtée dans.
Der Untersetzer ist eingeschlossen und mit Clip-Funktion zusammengesteckt.

Aqua Teraguard

Il sottovaso e i distanziali sono inclusi e vengono fissati ad incastro.
The saucer and the brackets are included and are fitted into.
Der Untersetzer und die Distanzhalter sind eingeschlossen und mit Clip-Funktion zusammenbefestigt.
La soucoupe et les espaceurs sont inclus et emboîtés



news
2019

diffusione dell'acqua per osmosi
water diffusion through osmosis's effect
diffusion de l'eau par osmose
Wasserdiffusion durch Osmose

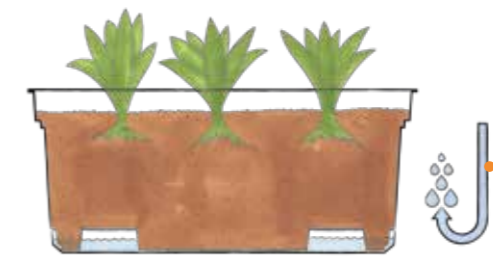

022
bianco/white
blanc/weiß



414
fog grey/ fog grey
brouillard gris/Nebel grau



406
bruno/brown
brun/braun



001
terracotta/terracotta colour
couleur terre/farbe terrakotta



404
cedro/cedar
cèdre/zeder



005
antracite/anthracite
anthracite/anthrazitgrau



022
bianco/white
blanc/weiß



414
fog grey/ fog grey
brouillard gris/Nebel grau



406
bruno/brown
brun/braun



001
terracotta/terracotta colour
couleur terre/farbe terrakotta



404
cedro/cedar
cèdre/zeder



005
antracite/anthracite
anthracite/anthrazitgrau

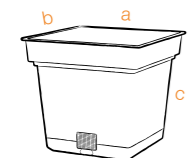

codice senza colore code without colour	Cm	dimensioni dimensions	litri liters	Confezione minima Minimum package	m ³	pezzi pallet pcs pallet	m ³
34 111 038	38	a38 b38 c38	29	4 38x38x47h	0,068	96 80x115x115h	1,06
34 111 047	47	a47 b47 c47	55	4 47x47x59h	0,130	128 100x115x230h	2,65

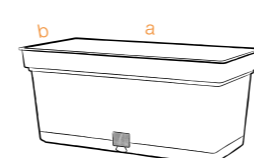

codice senza colore code without colour	Cm	dimensioni dimensions	litri liters	Confezione minima Minimum package	m ³	pezzi pallet pcs pallet	m ³
34 109 078	78	a78 b38 c38	66	4 78x38x47h	0,139	120 80x115x230h	2,12
34 109 098	98	a99 b47 c47	130	4 98x47x59h	0,272	64 100x115x230	2,65



linea
CLEAR



Orchidea



Madeira



Coimbra



Algarve



Porto



Plato



Plato Quadro

news
2019



Superficie lucida
Glossy surface
Surface brillante
Glänzende Oberfläche



Orchidea clear



024
trasparente/transparent
transparent/transparent



248
diana grey



252
vanilla



249
ida green



250
ruby pink



251
vanda

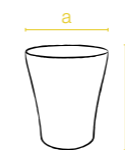

codice senza colore code without colour	Cm	dimensioni dimensions	litri liters	Confezione minima Minimum package	pezzi pallet pcs pallet	m ³	m ³
08 120 014	14	a13,5 b15,7	1,3	12 29x15x36h	720	0,015	80x120x115 1,10
08 120 016	16	a15,8 b18,6	2,2	14 48x17x30h	504	0,122	80x120x120 1,20



Superficie lucida
Glossy surface
Surface brillante
Glänzende Oberfläche



Madeira clear



024
trasparente/transparent
transparent/transparent

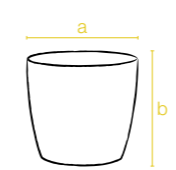

codice senza colore code without colour	Cm	dimensioni dimensions	litri liters	Confezione minima Minimum package	m ³	pezzi pallet pcs pallet	m ³
08 035 011	11	a11 b10	0,7	18 17x33x33h	0,01	756 80x120x115h	1,10
08 035 014	14	a14 b12,2	1,4	18 43x29x23h	0,02	432 80x120x110h	1,11
08 035 016	16	a16 b14,3	2,0	18 47x32x26h	0,03	360 80x120x120h	1,20
08 035 018	18	a18 b16,2	3,3	12 57x38x23h	0,05	192 80x120x110h	1,10
08 035 022	22	a22 b19,8	6,2	8 46x24x41h	0,04	112 80x120x100h	1,00
08 035 026	26	a25 b23,2	8,8	8 52x26x53h	0,07	96 80x120x120h	1,16



Superficie lucida
Glossy surface
Surface brillante
Glänzende Oberfläche



Coimbra clear



024
trasparente/transparent
transparent/transparent

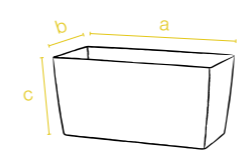

codice senza colore code without colour	Cm	dimensioni dimensions	litri liters	Confezione minima Minimum package	m ³	pezzi pallet pcs pallet	m ³
08 082 025	25	a26 b13 c12,5	3,6	12 40x27x25h	0,027	384 80x120x210h	1,15
08 082 030	30	a30 b15 c14	5,3	12 31x31x40h	0,038	144 80x120x100h	0,96



Superficie lucida
Glossy surface
Surface brillante
Glänzende Oberfläche



Algarve clear



024
trasparente/transparent
transparent/transparent

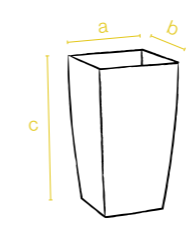

codice senza colore code without colour	Cm	dimensioni dimensions	litri liters	Confezione minima Minimum package	m ³	pezzi pallet pcs pallet	m ³
08 018 026	26	a15 b15 c26	4,4	12 46x16x51h	0,04	264 80x120x120h	1,15
08 018 035	35	a20 b20 c35	11,0	8 41x41x46h	0,07	64 80x120x120h	1,15
08 018 042	42	a25 b25 c42	20,0	4 51x26x51h	0,07	48 80x120x120h	1,15



disponibile nelle
misure 14 e 16
on the measures
14 and 16
dans les mesures
14 et 16
in den Größen
14 - 16



024

trasparente/transparent
transparent/transparent



024

trasparente/transparent
transparent/transparent



codice senza colore code without colour	Cm	dimensioni dimensions	litri liters		Confezione minima Minimum package	m ³	pezzi pallet pcs pallet	m ³
08 083 014	14	a14 b15	1,3	12	18 43x15x37h	0,02	594 80x120x125h	1,20
08 083 016	16	a16 b17,5	2,0	14	18 49x17x42h	0,03	288 80x120x100h	0,96
08 083 020	20	a20 b21,5	4,0	16	12 41x21x51h	0,04	168 80x120x118h	1,13
08 083 025	25	a25 b27	8,0	20	8 51x26x51h	0,07	96 80x120x118h	1,13

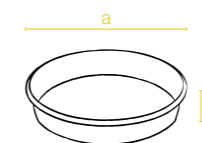

codice senza colore code without colour	Cm	dimensioni dimensions	Confezione minima Minimum package	m ³	pezzi pallet pcs pallet	m ³
08 086 012	12	a12 b2	18 12x12x12h	0,002	828 60x40x53h	0,12
08 086 014	14	a14 b2,3	18 14x14x12h	0,002	648 60x40x53h	0,12
08 086 016	16	a16 b2,7	12 16x16x12h	0,003	360 60x40x53h	0,12
08 086 020	20	a20 b3,3	8 20x20x12h	0,005	240 60x40x53h	0,12
08 086 024	24	a24 b4	6 24x24x12h	0,007	90 60x40x53h	0,12
08 086 028	28	a28 b4,7	4 28x28x12h	0,009	68 60x40x53h	0,12
08 086 032	32	a32 b5,2	2 32x32x8h	0,008	32 60x40x53h	0,12
08 086 036	36	a36 b5,2	2 36x36x8h	0,010	28 60x40x53h	0,12



Superficie lucida
Glossy surface
Surface brillante
Glänzende Oberfläche



**Porto e
Plato** clear



discreto ed elegante, Plato Quadro si abbina a qualsiasi tipo di vaso, anche in terracotta

discreet and elegant, Plato Quadro combines with different types of pots, also with the ones made of terracotta

discret et élégant, Plato Quadro se combine avec différents types de pots, aussi celles en terre cuite

diskret und stilvoll, Plato Quadro passt zu verschiedenen Topfarten, auch aus Terrakotta.



024
trasparente/transparent
transparent/transparent

ideale anche come svuota tasche o porta oggetti da scrivania

Also ideal as empties pockets or holding objects by desk

Aussi idéal comme conteneur ou porte-objets au bureau

Ideal auch als Ablageschale und für den Schreibtisch

Superficie lucida
Glossy surface
Surface brillante
Glänzende Oberfläche

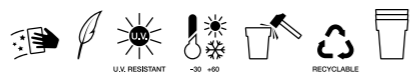

Plato quadro

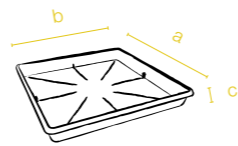

codice senza colore code without colour	Cm	dimensioni dimensions	Confezione minima Minimum package	m ³	pezzi pallet pcs pallet	m ³
08 122 027	27	a27 b27 c4	22 29x29x41h	0,07	352 80x120x100h	0,96
08 122 033	33	a33 b33 c4,5	20 34X34X41h	0,05	240 80x120x100h	1,15
08 122 038	38	a38 b38 c5	20 39X39X41h	0,06	240 80x120x100h	1,15

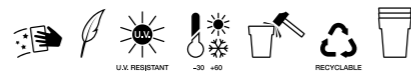

display
Plato
clear

display
Plato
quadro

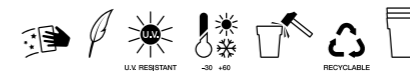

024

trasparente/transparent
transparent/transparent



024

trasparente/transparent
transparent/transparent

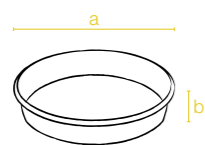

codice senza colore code without colour	Cm	dimensioni dimensions	Display box	m ³
08 086 016	16	a16 b2,7	40 17x17x41h	0,012
08 086 020	20	a20 b3,3	32 21x21x41h	0,018
08 086 024	24	a24 b4	26 25x25x41h	0,026
08 086 028	28	a28 b4,7	22 29x29x41h	0,034
08 086 032	32	a32 b5,2	22 34x34x41h	0,047
08 086 036	36	a36 b5,2	18 39x39x41h	0,062

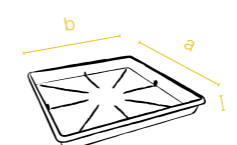

codice senza colore code without colour	Cm	dimensioni dimensions	Display box	m ³
08 122 027	27	a27 b27 c4	22 29x29x41h	0,034
08 122 033	33	a33 b33 c4,5	20 34x34x41h	0,047
08 122 038	38	a38 b38 c5	26 39x39x41h	0,062



linea
PASTEL



Madeira



Santiago



Superficie lucida
Glossy surface
Surface brillante
Glänzende Oberfläche



Madeira pastel



412
acquamarina/aquamarine
aigue-marine/aquamarin



410
ghiaccio/ice
glace/eis



409
malva/mauve
mauve/mauve



411
porcellana/porcelain
porcelaine/porzellan

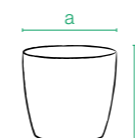

codice senza colore code without colour	Cm	dimensioni dimensions	litri liters	Confezione minima Minimum package	m ³	pezzi pallet pcs pallet	m ³
27 035 011	11	a 11 b 10	0,7	18 17x33x33h	0,01	756 80x120x115h	1,10
27 035 014	14	a 14 b 12,2	1,4	18 43x29x23h	0,02	432 80x120x110h	1,06
27 035 016	16	a 16 b 14,3	2	18 47x32x26h	0,04	360 80x120x120h	1,15
27 035 018	18	a 18 b 16,2	3,3	12 57x38x23h	0,05	192 80x120x110h	1,06
27 035 022	22	a 22 b 19,8	6,2	8 46x24x41h	0,45	112 80x120x100h	0,96
27 035 026	26	a 25 b 23,2	8,8	8 52x26x53h	0,07	96 80x120x120h	1,15



ideale come porta vaso
 ideal as cachepot
 idéal comme pot de fleurs
 ideal als Übertopf

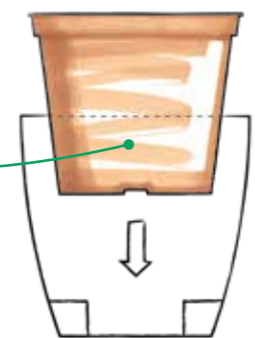

Linea Flortec
 pagina 183



412
 acquamarina/aquamarine
 algue-marine/aquamarin



410
 ghiaccio/ice
 glace/eis



409
 malva/mauve
 mauve/mauve



411
 porcellana/porcelain
 porcelaine/porzellan

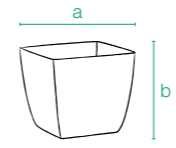

codice senza colore code without colour	Cm	dimensioni dimensions	litri liters	Confezione minima Minimum package	pezzi pallet pcs pallet	m ³
27 100 011	11	a11 b10	1	18 23x12x31h	1458	0,01
27 100 013	13	a13 b12	1,5	18 28x15x33h	1080	0,01
27 100 015	15	a15 b14,5	2,5	12 33x17x33h	504	0,02
27 100 020	20	a19 b17	5	8 21x21x42h	240	0,02

Superficie lucida
 Glossy surface
 Surface brillante
 Glänzende Oberfläche

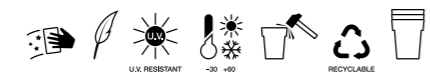

Santiago
 pastel

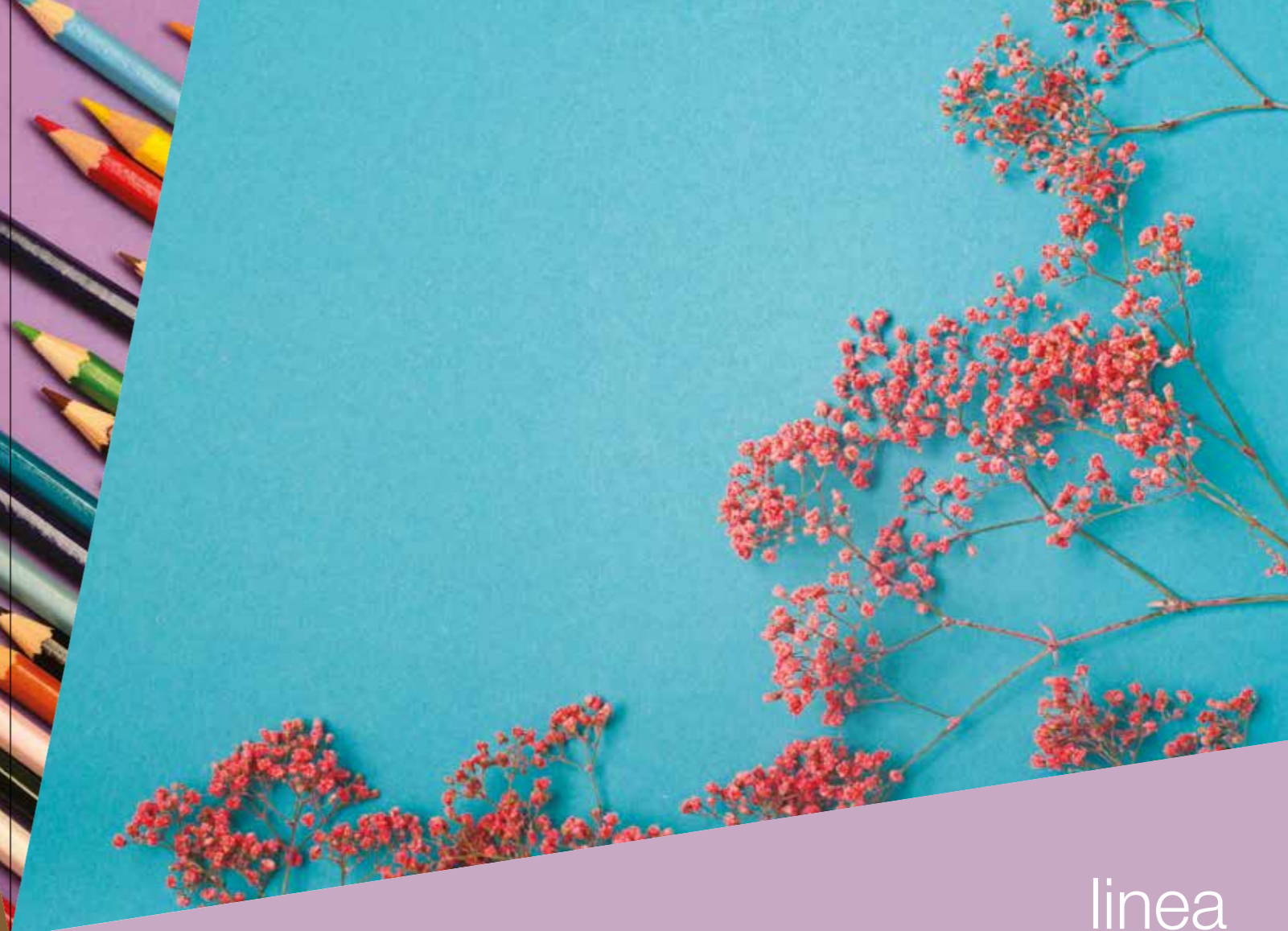

linea
COLOUR



Trio Madeira



Sunrise



Orchidea



Plato



Santiago



Estoril



Porto



Algarve



Madeira



Coimbra

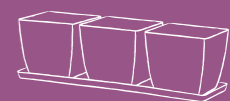

Trio Santiago



022
bianco/white
blanc/weiß



404
cedro/cedar
cèdre/zeder



406
bruno/brown
brun/braun



010
rosso/red
rouge/rot



006
nero/black
noir/schwarz

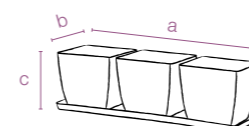

codice senza colore code without colour	Cm	dimensioni dimensions	Confezione minima Minimum package	m ³	pezzi pallet pcs pallet	m ³
08 126 035	35	a35 b11 c11	10 57x38x23h	0,05	200 80x120x125h	1,20



Superficie lucida
Glossy surface
Surface brillante
Glänzende Oberfläche



Trio Santiago



022
bianco/white
blanc/weiß



404
cedro/cedar
cèdre/zeder



406
bruno/brown
brun/braun



010
rosso/red
rouge/rot



006
nero/black
noir/schwarz



Superficie lucida
Glossy surface
Surface brillante
Glänzende Oberfläche



U.V. RESISTANT
-20 +100
RECYCLABLE

Trio Madeira

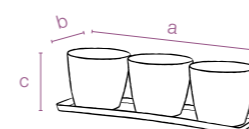

codice senza colore code without colour	Cm	dimensioni dimensions	Confezione minima Minimum package	m ³	pezzi pallet pcs pallet	m ³
08 129 035	35	a35 b11 c11	10 57x38x23h	0,05	200 80x120x125h	1,20



Superficie lucida
Glossy surface
Surface brillante
Glänzende Oberfläche



Sunrise



022
bianco/white
blanc/weiß



401
peonia/peony
pivoine/pfingstrose



402
lilyum/lilyum
lilyum/lilyum



404
cedro/cedar
cèdre/zeder



406
bruno/brown
brun/braun



010
rosso/red
rouge/rot



006
nero/black
noir/schwarz

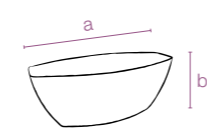

codice senza colore code without colour	Cm	dimensioni dimensions	litri liters	Confezione minima Minimum package	m ³	pezzi pallet pcs pallet	m ³
08 119 036	36	a36,5 b15 b14	5	12 38x16x44h	0,03	384 80x120x120h	1,15



Superficie lucida
Glossy surface
Surface brillante
Glänzende Oberfläche



Orchidea



022
bianco/white
blanc/weiß



401
peonia/peony
pivoine/pfingstrose



402
lilyum/lilyum
lilyum/lilyum



404
cedro/cedar
cèdre/zeder



406
bruno/brown
brun/braun



006
nero/black
noir/schwarz

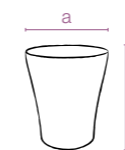

codice senza colore code without colour	Cm	dimensioni dimensions	litri liters	Confezione minima Minimum package	pezzi pallet pcs pallet	m ³	m ³
08 120 014	14	a13,5 b15,7	1,3	12 28x15x34h	720	0,014	80x120x115 1,10
08 120 016	16	a15,8 b18,6	2,2	12 32x17x35h	504	0,019	80x120x120 1,15



Superficie lucida
Glossy surface
Surface brillante
Glänzende Oberfläche



Plato



022
bianco/white
blanc/weiß



010
rosso/red
rouge/rot



401
peonia/peony
pivoine/pfingstrose



402
lilyum/lilyum
lilyum/lilyum



028
turchese/turquoise
turquoise/türkis



404
cedro/cedar
cèdre/zeder



407
salvia/sage
sauge/salbei



406
bruno/brown
brun/braun



006
nero/black
noir/schwarz

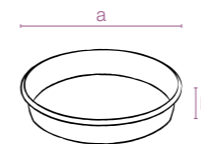

codice senza colore code without colour	Cm	dimensioni dimensions	Confezione minima Minimum package	m ³	pezzi pallet pcs pallet	m ³
08 086 012	12	a12 b2	18 12x12x12h	0,002	828 60x40x53h	0,13
08 086 014	14	a14 b2,3	18 14x14x12h	0,002	648 60x40x53h	0,13
08 086 016	16	a16 b2,7	12 16x16x12h	0,003	360 60x40x53h	0,13
08 086 020	20	a20 b3,3	8 20x20x12h	0,005	240 60x40x53h	0,13
08 086 024	24	a24 b4	6 24x24x12h	0,007	90 60x40x53h	0,13
08 086 028	28	a28 b4,7	4 28x28x12h	0,009	68 60x40x53h	0,13
08 086 032	32	a32 b5,2	2 32x32x8h	0,008	32 60x40x53h	0,13



ideale come porta vaso
 ideal as cachepot
 idéal comme pot de fleurs
 ideal als Übertopf

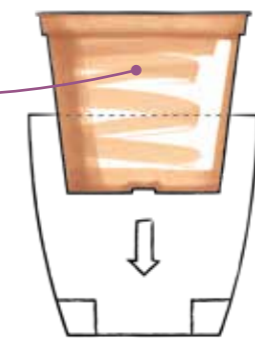

Linea Flortec
 pagina 183

- 
022
 bianco/white
 blanc/weiß
- 
401
 peonia/peony
 pivoine/pfingstrose
- 
402
 lilyum/lilyum
 lilyum/lilyum
- 
028
 turchese/turquoise
 turquoise/türkis
- 
404
 cedro/cedar
 cèdre/zeder
- 
407
 salvia/sage
 sauge/salbei
- 
406
 bruno/brown
 brun/braun
- 
010
 rosso/red
 rouge/rot
- 
006
 nero/black
 noir/schwarz

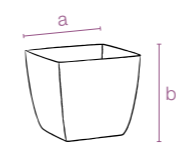

codice senza colore code without colour	Cm	dimensioni dimensions	litri liters	Confezione minima Minimum package	pezzi pallet pcs pallet	m ³
08 100 011	11	a 11 b 10	1	18 23x12x31h	80x120x100h	0,01
08 100 013	13	a 13 b 12	1,5	18 28x15x33h	80x120x115h	0,01
08 100 015	15	a 15 b 14,5	2,5	12 33x17x33h	80x120x115h	0,02
08 100 020	20	a 19 b 17	5	8 21x21x42h	80x120x100h	0,02

Superficie lucida
 Glossy surface
 Surface brillante
 Glänzende Oberfläche

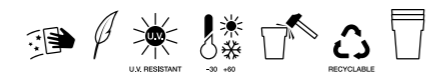

Santiago

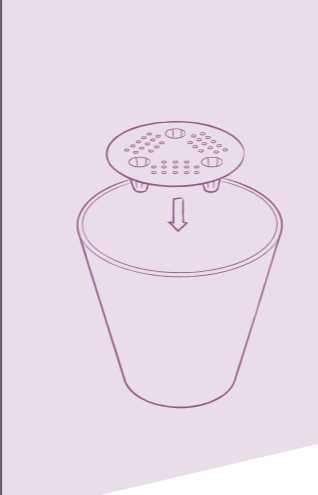

- 
022
 bianco/white
 blanc/weiß
- 
401
 peonia/peony
 pivoine/pfingstrose
- 
402
 lilyum/lilyum
 lilyum/lilyum
- 
404
 cedro/cedar
 cèdre/zeder
- 
407
 salvia/sage
 sauge/salbei
- 
406
 bruno/brown
 brun/braun
- 
006
 nero/black
 noir/schwarz
- 
Plato
 pagina 120

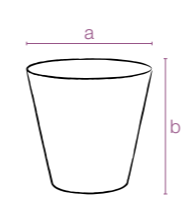

codice senza colore code without colour	Cm	dimensioni dimensions	litri liters	Confezione minima Minimum package	m ³	pezzi pallet pcs pallet	m ³
08 037 016	16	a16 b15	1,6	14	12 33x17x33h	0,02	1008 80x120x215h 2,1
08 037 020	20	a20 b19	3,2	16	8 21x21x43h	0,02	600 80x120x230h 2,2
08 037 025	25	a25 b23,5	6,2	20	6 26x26x42h	0,03	360 80x120x230h 2,2
08 037 030	30	a30 b28	11,8	24	4 31x31x44h	0,03	160 80x120x235h 2,3

Superficie lucida
Glossy surface
Surface brillante
Glänzende Oberfläche

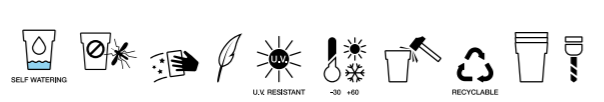

Estoril water reserve



022
bianco/white
blanc/weiß



406
bruno/brown
brun/braun



010
rosso/red
rouge/rot



404
cedro/cedar
cèdre/zeder



006
nero/black
noir/schwarz



Plato
pagina 120



Superficie lucida
Glossy surface
Surface brillante
Glänzende Oberfläche



Porto

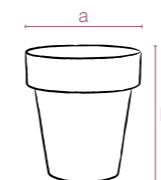

codice senza colore code without colour	Cm	dimensioni dimensions	litri liters		Confezione minima Minimum package	m ³	pezzi pallet pcs pallet	m ³
08 083 014	14	a14 b15	1,3	12	18 43x15x37h	0,02	594 80x120x125h	1,20
08 083 016	16	a16 b17,5	2,0	14	18 49x17x42h	0,03	288 80x120x100h	0,96
08 083 020	20	a20 b21,5	4,0	16	12 41x21x51h	0,04	168 80x120x118h	1,13
08 083 025	25	a25 b27	8,0	20	8 51x26x51h	0,07	96 80x120x118h	1,13
08 083 030	30	a30 b32,5	14,0	24	6 31x31x74h	0,07	108 80x120x235h	2,26
08 083 035	35	a35 b38	23,0	28	4 36x36x69h	0,09	72 80x120x235h	2,26
08 083 040	40	a40 b43,5	34,0	32	2 41x41x57h	0,09	42 80x120x227h	2,18



Plato
pagina 120



Porto

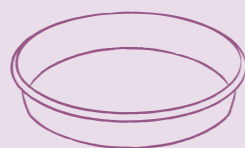

Plato



PORTO 14 + PLATO 12

PORTO 16 + PLATO 14

PORTO 20 + PLATO 16

PORTO 25 + PLATO 20

PORTO 30 + PLATO 24

PORTO 35 + PLATO 28

PORTO 40 + PLATO 32

Porto ha il supporto per **orchidea** nelle misure 14 e 16

on the measures 14 and 16
Porto is featured with **orchids's** brackets

dans les mesures 14 et 16 Porto
a un support pour les **orchidées**

Unterstützung für **Orchideen** in
den Größen 14 - 16 vom Topf
"Porto"

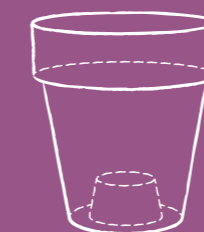



022
bianco/white
blanc/weiß

010
rosso/red
rouge/rot

406
bruno/brown
brun/braun

006
nero/black
noir/schwarz

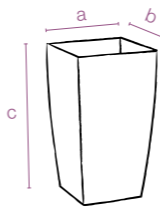

codice senza colore code without colour	Cm	dimensioni dimensions	litri liters	Confezione minima Minimum package	m ³	pezzi pallet pcs pallet	m ³
08 018 026	26	a15 b15 c26	4,4	12 46x16x51h	0,04	264 80x120x120h	1,15
08 018 035	35	a20 b20 c35	11,0	8 41x41x46h	0,08	64 80x120x120h	1,15
08 018 042	42	a25 b25 c42	20,0	4 51x26x51h	0,07	48 80x120x120h	1,15

Superficie lucida
Glossy surface
Surface brillante
Glänzende Oberfläche



Algarve

1

Algarve

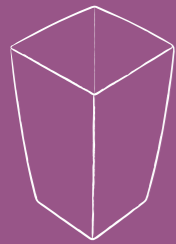

ideale per fiori recisi
ideal for cut flowers idéal
pour les fleurs coupées
ideal für Schnittblumen



3

Algarve come portavaso

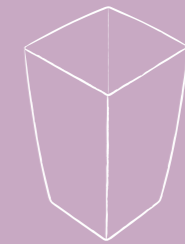

+

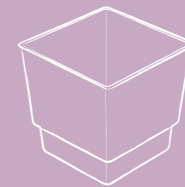

+



Linea **Flortec**
pagina 183

2

Algarve + self watering

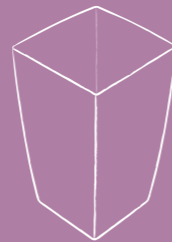

+

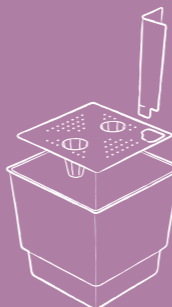

con riserva d'acqua
with Self-watering system
avec réserve d'eau
mit Wasserspeicher

ideale come porta vaso
ideal as cachepot
idéal comme pot de fleurs
ideal als Übertopf

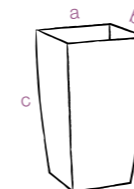

codice senza colore code without colour	Cm	dimensioni dimensions	litri liters	Confezione minima Minimum package	m ³	pezzi pallet pcs pallet	m ³
08 081 026	26	a15 b15 c26	4,4	12 31x31x61h	0,05	100	80x60x115h 0,55
08 081 035	35	a20 b20 c35	11,0	8 41x41x57h	0,09	48	80x60x115h 0,55
08 081 042	42	a25 b25 c42	20,0	4 51x26x68h	0,09	18	80x60x115h 0,55



022
bianco/white
blanc/weiß



401
peonia/peony
pivoine/pfingstrose



402
lilyum/lilyum
lilyum/lilyum



404
cedro/cedar
cèdre/zeder



407
salvia/sage
saugue/salbei



406
bruno/brown
brun/braun



010
rosso/red
rouge/rot



028
turchese/turquoise
turquoise/türkis



006
nero/black
noir/schwarz

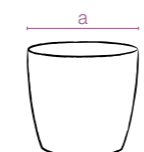

codice senza colore code without colour	Cm	dimensioni dimensions	litri liters	Confezione minima Minimum package	m ³	pezzi pallet pcs pallet	m ³
08 035 011	11	a11 b10	0,7	18 17x33x33h	0,02	756 80x120x115h	1,10
08 035 014	14	a14 b12,2	1,4	18 43x29x23h	0,03	432 80x120x110h	1,06
08 035 016	16	a16 b14,3	2,0	18 47x32x26h	0,04	360 80x120x120h	1,15
08 035 018	18	a18 b16,2	3,3	12 57x38x23h	0,05	192 80x120x110h	1,06
08 035 022	22	a22 b19,8	6,2	8 46x24x41h	0,04	112 80x120x100h	0,96
08 035 026	26	a25 b23,2	8,8	8 52x26x53h	0,07	96 80x120x120h	1,15



Superficie lucida
Glossy surface
Surface brillante
Glänzende Oberfläche



Madeira
luxy



022
bianco/white
blanc/weiß



010
rosso/red
rouge/rot



404
cedro/cedar
cèdre/zeder



406
bruno/brown
brun/braun



006
nero/black
noir/schwarz

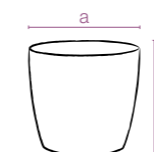

codice senza colore code without colour	Cm	dimensioni dimensions	litri liters	Confezione minima Minimum package	m ³	pezzi pallet pcs pallet	m ³
08 017 014	14	a14 b12,2	1,4	18 43x29x23h	0,03	432 80x120x110h	1,06
08 017 018	18	a18 b16,2	3,3	12 57x38x23h	0,05	192 80x120x110h	1,06
08 017 022	22	a22 b19,8	6,2	8 46x24x41h	0,04	112 80x120x100h	0,96



Superficie opaca
Matt finished
Surface opaque
Matt-Oberfläche



Madeira



ideale come porta vaso
 idéal as cachepot
 idéal comme pot de fleurs
 ideal als Übertopf

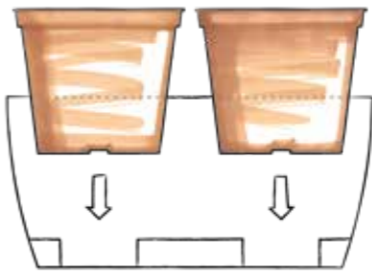

Linea Flortec
 pagina 183

COIMBRA cm 30
 Contiene 2 vasi da 14 cm
 Suitable to contain 2 pots cm 14
 Contient 2 pots de 14 cm
 Platz für zwei Vasen 14 cm

COIMBRA cm 25
 Contiene 2 vasi cm 12
 Suitable to contain 2 pots cm 12
 Contient 2 pots de 12 cm
 Platz für zwei Vasen 12 cm



022
 bianco/white
 blanc/weiß



010
 rosso/red
 rouge/rot



404
 cedro/cedar
 cèdre/zeder



406
 bruno/brown
 brun/braun



006
 nero/black
 noir/schwarz



Superficie lucida
 Glossy surface
 Surface brillante
 Glänzende Oberfläche



Coimbra

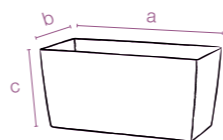

codice senza colore code without colour	Cm	dimensioni dimensions	litri liters	Confezione minima Minimum package	m ³	pezzi pallet pcs pallet	m ³
08 082 025	25	a26 b13 c12,5	4	12 40x27x25h	0,027	384 80x120x120h	1,15
08 082 030	30	a30 b15 c14	5	12 31x31x40h	0,038	144 80x120x100h	0,96



linea
BASIC



Cilindro



Campana



Ciotola Coste



Vaso Coste



Ciotola
Con Sottovaso



Sottovaso



Quadro



Cassettone



Sottovaso
Quadro



Sottocassettone



Cassetta Mare



Cassetta Cortina



Cassetta
Panorama



Cassetta Tirol



Cassetta
Portofino



Cassetta Coste



Sottocassetta



022
bianco/white
blanc/weiß



403
corda/cord
corde/seil



406
bruno/brown
brun/braun



408
cacao/cocoa
cacao/kakao



414
fog grey/fog grey
brouillard gris/Nebel grau



018
ciclamino/cyclamen
cyclamen/zyklamfarbe



019
lilla/lilac
lilas/lila



404
cedro/cedar
cèdre/zeder

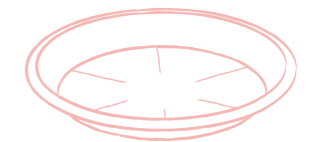

Sottovaso
pagina 148

codice senza colore code without colour	Cm	dimensioni dimensions	litri liters	Confezione minima Minimum package	m ³	pezzi pallet pcs pallet	m ³
01 001 015	15	a 15 b 10,8	1,2	20 15x15x30h	0,007	2880	80x120x110h 1,06
01 001 018	18	a 18 b 12,8	2	20 18x18x32h	0,010	2240	80x120x110h 1,06
01 001 020	20	a 20 b 14,2	2,5	20 20x20x36h	0,014	1440	80x120x120h 1,15
01 001 025	25	a 25 b 17,7	4,8	10 25x25x30h	0,019	720	80x120x110h 1,06
01 001 030	30	a 30 b 21,2	8,5	10 30x30x34h	0,031	400	80x120x110h 1,06
01 001 035	35	a 35 b 24,6	13	10 35x35x39h	0,048	300	80x120x120h 1,15
01 001 040	40	a 40 b 27,2	19	10 40x40x42h	0,067	300	80x120x120h 1,15
01 001 045	45	a 45 b 31,4	29	10 45x45x46h	0,093	330	80x120x230h 2,21
01 001 050	50	a 50 b 34,9	41	5 50x50x42h	0,105	380	100x120x220h 2,64
01 001 060	60	a 60 b 41,8	69	5 60x60x50h	0,180	170	80x120x225h 2,16
01 001 070	70	a 70 b 49	120	5 70x70x67h	0,328	40	80x80x227h 1,45

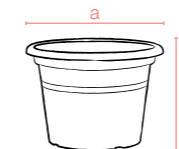

Superficie opaca
Matt finished
Surface opaque
Matt-Oberfläche



Cilindro
colour



Superficie opaca
Matt finished
Surface opaque
Matt-Oberfläche



Cilindro classic



001

terracotta/terracotta colour
couleur terre/farbe terrakotta



005

antracite/anthracite
anthracite/anthrazitgrau



002

verde/green
vert/grün

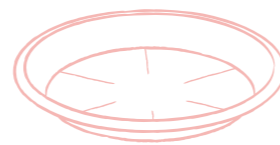

Sottovaso
pagina 148

codice senza colore code without colour	Cm	dimensioni dimensions	litri liters		Confezione minima Minimum package	m ³	pezzi pallet pcs pallet		m ³
01 001 015	15	a 15 b 10,8 1,2	14	20	15x15x30h	0,007	2880	80x120x110h	1,06
01 001 018	18	a 18 b 12,8 2	16	20	18x18x32h	0,010	2240	80x120x110h	1,06
01 001 020	20	a 20 b 14,2 2,5	18	20	20x20x36h	0,014	1440	80x120x120h	1,15
01 001 025	25	a 25 b 17,7 4,8	22	10	25x25x30h	0,019	720	80x120x110h	1,06
01 001 030	30	a 30 b 21,2 8,5	26	10	30x30x34h	0,031	400	80x120x110h	1,06
01 001 035	35	a 35 b 24,6 13	30	10	35x35x39h	0,048	300	80x120x120h	1,15
01 001 040	40	a 40 b 27,2 19	35	10	40x40x42h	0,067	300	80x120x120h	1,15
01 001 045	45	a 45 b 31,4 29	40	10	45x45x46h	0,093	330	80x120x230h	2,21
01 001 050	50	a 50 b 34,9 41	45	5	50x50x42h	0,105	380	100x120x220h	2,64
01 001 060	60	a 60 b 41,8 69	52	5	60x60x50h	0,180	170	80x120x225h	2,16
01 001 070	70	a 70 b 49 120	65	5	70x70x67h	0,328	40	80x80x227h	1,45
01 001 090	90	a 90 b 64 240	80	5	90x90x82h	0,664	35	100x120x236h	2,83

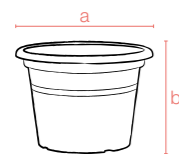

Superficie opaca
Matt finished
Surface opaque
Matt-Oberfläche



Campana classic



001

terracotta/terracotta colour
couleur terre/farbe terrakotta



005

antracite/anthracite
anthracite/anthrazitgrau

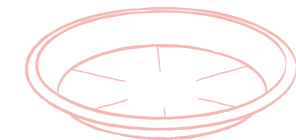

Sottovaso
pagina 148

codice senza colore code without colour	Cm	dimensioni dimensions	litri liters		Confezione minima Minimum package	m ³	pezzi pallet pcs pallet		m ³
01 002 020	20	a 20 b 13,8 2,2	18	20	20x20x40h	0,01	1080	80x120x113h	1,08
01 002 025	25	a 25 b 17,2 4,4	22	10	25x25x33h	0,02	600	80x120x115h	1,10
01 002 030	30	a 30 b 20,7 7,5	26	10	30x30x37h	0,03	400	80x120x120h	1,15
01 002 035	35	a 35 b 24,1 12	30	10	35x35x41h	0,05	240	80x120x113h	1,08
01 002 040	40	a 40 b 26,8 16,5	35	10	40x40x45h	0,07	240	80x120x120h	1,15
01 002 045	45	a 45 b 31,1 25,5	40	10	45x45x51h	0,10	400	100x120x213h	2,56
01 002 050	50	a 50 b 34,6 35	45	5	50x50x45h	0,11	320	100x120x225h	2,70
01 002 060	60	a 60 b 41,4 60	52	5	60x60x53h	0,19	260	120x120x215h	2,58

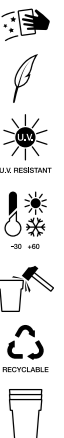
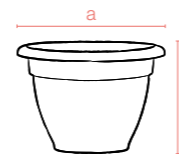

Ciotola coste

Superficie opaca / Matt finished
Surface opaque / Matt-Oberfläche



001
terracotta/terracotta colour
couleur terre/farbe terrakotta



005
antracite/anthracite
anthracite/anthrazitgrau

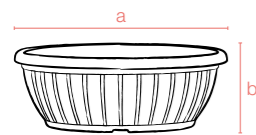

codice senza colore code without colour	Cm	dimensioni dimensions	litri liters		Confezione minima Minimum package	m ³	pezzi pallet pcs pallet	m ³
01 010 020	20	a20 b8	1,6	20	20x20x35h	0,01	1200	80x120x110h 1,06
01 010 025	25	a25 b9	3	26	25x25x25h	0,01	600	80x120x105h 1,01
01 010 030	30	a30 b11	5,2	30	30x30x29h	0,02	360	80x120x103h 0,99
01 010 035	35	a35 b12,5	8	35	35x35x31h	0,03	280	80x120x114h 1,09
01 010 040	40	a40 b14	12	40	40x40x38h	0,06	180	80x120x107h 1,03
01 010 050	50	a50 b18	24	52	50x50x43h	0,10	280	100x120x220h 2,64

Vaso coste

Superficie opaca / Matt finished
Surface opaque / Matt-Oberfläche



001
terracotta/terracotta colour
couleur terre/farbe terrakotta



005
antracite/anthracite
anthracite/anthrazitgrau

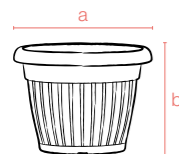

codice senza colore code without colour	Cm	dimensioni dimensions	litri liters		Confezione minima Minimum package	m ³	pezzi pallet pcs pallet	m ³
01 003 020	20	a20 b14,8	2,5	18	20x20x46h	0,01	900	80x120x115h 1,10
01 003 025	25	a25 b18,4	4,9	22	25x25x52h	0,03	240	80x120x105h 1,01
01 003 030	30	a30 b21,8	8,4	26	30x30x56h	0,05	160	80x120x105h 1,01
01 003 035	35	a35 b25,7	13	30	35x35x59h	0,07	120	80x120x110h 1,06
01 003 040	40	a40 b29,4	20	35	40x40x61h	0,09	120	80x120x115h 1,10
01 003 045	45	a45 b33,1	29	40	45x45x64h	0,13	150	80x120x215h 2,06
01 003 050	50	a50 b36,8	40	45	50x50x51h	0,12	200	100x120x227h 2,72
01 003 060	60	a60 b44,1	70	52	60x60x58h	0,20	100	80x120x210h 2,11

Ciotola con sottovaso

Superficie opaca / Matt finished
Surface opaque / Matt-Oberfläche



001
terracotta/terracotta colour
couleur terre/farbe terrakotta



005
antracite/anthracite
anthracite/anthrazitgrau



406
bruno/brown
brun/braun

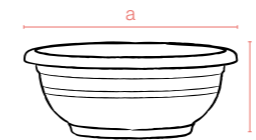

codice senza colore code without colour	Cm	dimensioni dimensions	litri liters		Confezione minima Minimum package	m ³	pezzi pallet pcs pallet	m ³
01 009 030	30	a30 b11,5	5	incl	10 30x30x25h	0,02	400	80x120x105h 1,01
01 009 040	40	a40 b15,5	11,5	incl	10 40x40x32h	0,05	240	80x120x103h 0,99
01 009 050	50	a50 b18		incl	10 50x50x38h	0,09	360	100x120x212h 2,54

misura 30 cm disponibile
anche con gancio
hook available for size 30 cm
Haken für 30er Größe
verfügbar
crochet disponible pour
mesure 30 cm

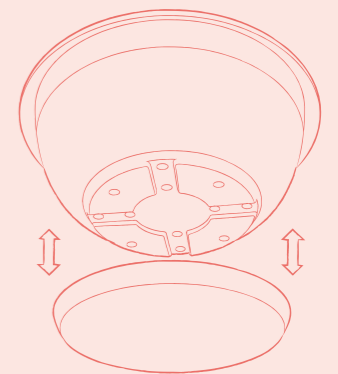

Il sottovaso è incluso e viene fissato ad incastro.

The saucer is included and is fitted into.
La soucoupe est inclus et est emboîtée dans.

Der Untersetzer ist eingeschlossen und mit Clip-Funktion zusammengesteckt.

codice senza colore code without colour	Cm	dimensioni dimensions	litri liters		Confezione minima Minimum package	m ³	pezzi pallet pcs pallet	m ³
01 308 030	30	a30 b11,5	5	incl	10 30x30x25h	0,02	400	80x120x105h 1,01

Sottovaso colour

Superficie opaca / Matt finished
Surface opaque / Matt-Oberfläche



022
bianco/white
blanc/weiß



403
corda/cord
corde/seil



406
bruno/brown
brun/braun



408
cacao/cocoa
cacao/kakao



414
fog grey/fog grey
brouillard gris/Nebel grau



018
ciclamino/cyclamen
cyclamen/zyklamfarbe



019
lilla/lilac
lilas/lila



404
cedro/cedar
cèdre/zeder

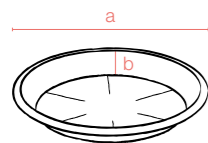

codice senza colore code without colour	Cm	dimensioni dimensions	Confezione minima Minimum package	m ³	pezzi pallet pcs pallet	m ³
01 011 014	14	a14 b1,8	20 14x14x32h	0,006	2200	0,12
01 011 016	16	a16 b1,9	20 16x16x32h	0,008	1400	0,12
01 011 018	18	a18 b2,3	20 18x18x32h	0,010	1200	0,12
01 011 022	22	a22 b3	10 22x22x24h	0,012	500	0,12
01 011 026	26	a26 b3,7	50 26x26x24h	0,016	300	0,12
01 011 030	30	a30 b4,1	25 30x30x15h	0,014	200	0,12
01 011 035	35	a35 b5,1	25 35x35x15h	0,018	125	0,12
01 011 040	40	a40 b5,2	25 40x40x15h	0,024	125	0,12
01 011 045	45	a45 b5,5	25 45x45x17h	0,034	600	1,10
01 011 052	52	a52 b6,6	25 52x52x20h	0,051	350	0,96
01 011 065	66	a66 b6,1	5 66x66x10h	0,039	130	0,74

Sottovaso classic

Superficie opaca / Matt finished
Surface opaque / Matt-Oberfläche

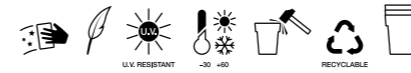

001
terracotta/terracotta colour
couleur terre/farbe terrakotta



005
antracite/anthracite
anthracite/anthrazitgrau



002
verde/green
vert/grün

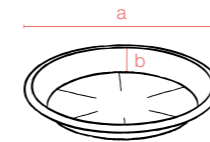

codice senza colore code without colour	Cm	dimensioni dimensions	Confezione minima Minimum package	m ³	pezzi pallet pcs pallet	m ³
01 011 012	12	a12 b1,5	100 12x12x28h	0,004	2800	0,12
01 011 014	14	a14 b1,8	100 14x14x32h	0,006	2200	0,12
01 011 016	16	a16 b1,9	100 16x16x32h	0,008	1400	0,12
01 011 018	18	a18 b2,3	100 18x18x32h	0,010	1200	0,12
01 011 020	20	a20 b2,9	50 20x20x20h	0,008	700	0,12
01 011 022	22	a22 b3	50 22x22x24h	0,012	500	0,12
01 011 024	24	a24 b3,6	50 24x24x24h	0,012	450	0,12
01 011 026	26	a26 b3,7	50 26x26x24h	0,016	300	0,12
01 011 028	28	a28 b4,1	50 28x28x24h	0,019	300	0,12
01 011 030	30	a30 b4,1	25 30x30x15h	0,014	200	0,12
01 011 035	35	a35 b5,1	25 35x35x15h	0,018	125	0,12
01 011 040	40	a40 b5,2	25 40x40x15h	0,024	125	0,12
01 011 045	45	a45 b5,5	25 45x45x17h	0,034	600	1,10
01 011 052	52	a52 b6,6	25 52x52x20h	0,051	350	0,96
01 011 065	66	a66 b6,1	5 66x66x10h	0,039	130	0,74
01 011 080	80	a80 b6,6	5 80x80x10h	0,077	130	1,37



Superficie opaca
Matt finished
Surface opaque
Matt-Oberfläche



Quadro colour



403
corda/cord
corde/seil



406
bruno/brown
brun/braun



408
cacao/cocoa
cacao/kakao



Sottovaso
pagina 154

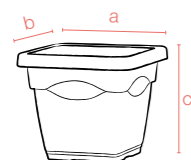

codice senza colore code without colour	Cm	dimensioni dimensions	litri liters		Confezione minima Minimum package	m ³	pezzi pallet pcs pallet	m ³
01 007 032	32	a32 b32 c27,8	14	27	10 32x32x49h	0,05	210 80x120x115h	1,10
01 007 038	38	a38 b38 c33,5	25	33	10 38x38x56h	0,08	150 80x120x110h	1,06
01 007 045	45	a45 b45 c40,1	42	38	10 45x45x69h	0,14	200 100x120x212h	2,54



Superficie opaca
Matt finished
Surface opaque
Matt-Oberfläche



Quadro classic



001
terracotta/terracotta colour
couleur terre/farbe terrakotta



005
antracite/anthracite
anthracite/anthrazitgrau



Sottovaso
pagina 154

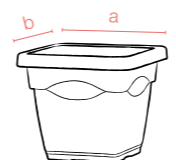

codice senza colore code without colour	Cm	dimensioni dimensions	litri liters		Confezione minima Minimum package	m ³	pezzi pallet pcs pallet	m ³
01 007 032	32	a32 b32 c27,8	14	27	10 32x32x49h	0,05	210 80x120x115h	1,10
01 007 038	38	a38 b38 c33,5	25	33	10 38x38x56h	0,08	150 80x120x110h	1,06
01 007 045	45	a45 b45 c40,1	42	38	10 45x45x69h	0,14	200 100x120x212h	2,54





Superficie opaca
Matt finished
Surface opaque
Matt-Oberfläche



Cassettone colour



403

corda/cord
corde/seil



406

bruno/brown
brun/braun



408

cacao/cocoa
cacao/kakao



Sottocassettone
pagina 155

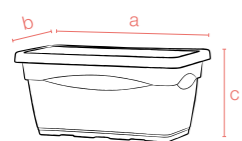

codice senza colore code without colour	Cm	dimensioni dimensions		litri liters		Confezione minima Minimum package	m ³	pezzi pallet pcs pallet		m ³
01 008 060	60	a60	b32	c27,5	31	60	5	60x32x37h	0,07	420 100x120x224h 2,69
01 008 080	80	a80	b37	c32,8	60	80	5	80x37x43h	0,12	210 80x120x224h 2,15
01 008 100	100	a100	b40	c37,5	92	100	5	100x40x54h	0,21	100 100x120x228h 2,74



Superficie opaca
Matt finished
Surface opaque
Matt-Oberfläche



Cassettone classic



001

terracotta/terracotta colour
couleur terre/farbe terrakotta



005

antracite/anthracite
anthracite/anthrazitgrau



Sottocassettone
pagina 155

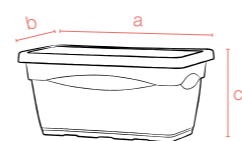

codice senza colore code without colour	Cm	dimensioni dimensions		litri liters		Confezione minima Minimum package	m ³	pezzi pallet pcs pallet		m ³
01 008 060	60	a60	b32	c27,5	31	60	5	60x32x37h	0,07	420 100x120x224h 2,69
01 008 080	80	a80	b37	c32,8	60	80	5	80x37x43h	0,12	210 80x120x224h 2,15
01 008 100	100	a100	b40	c37,5	92	100	5	100x40x54h	0,21	100 100x120x228h 2,74



Sottovaso Quadro

colour

Superficie opaca / Matt finished
Surface opaque / Matt-Oberfläche

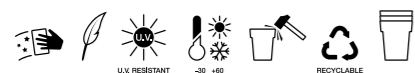

403
corda/cord
corde/seil



406
bruno/brown
brun/braun



408
cacao/cocoa
cacao/kakao

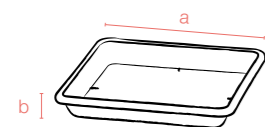

codice senza colore code without colour	Cm	dimensioni dimensions	Confezione minima Minimum package	m³	pezzi pallet pcs pallet	m³
01 013 027	27	a27 b4	10 27x27x3,9h	0,01	140 60x40x50h	0,12
01 013 033	33	a33 b5	10 33x33x13h	0,01	70 60x40x50h	0,12
01 013 038	38	a37,5 b6	10 38x38x16h	0,02	50 60x40x50h	0,12

Sottocassettone

colour

Superficie opaca / Matt finished
Surface opaque / Matt-Oberfläche



403
corda/cord
corde/seil



406
bruno/brown
brun/braun



408
cacao/cocoa
cacao/kakao

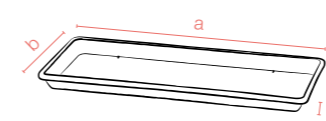

codice senza colore code without colour	Cm	dimensioni dimensions	Confezione minima Minimum package	m³	pezzi pallet pcs pallet	m³
01 014 060	60	a56 b28 c4,3	5 56x28x7h	0,01	60 60x40x50h	0,12
01 014 080	80	a75 b32 c5,1	5 75x33x9h	0,02	285 80x120x115h	1,10
01 014 100	100	a95 b35 c5,2	5 95x35x11h	0,03	160 80x120x115h	1,10

Sottovaso Quadro

Superficie opaca / Matt finished
Surface opaque / Matt-Oberfläche



001
terracotta/terracotta colour
couleur terre/farbe terrakotta



005
antracite/anthracite
anthracite/anthrazitgrau

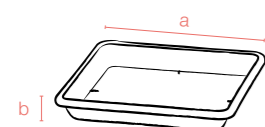

codice senza colore code without colour	Cm	dimensioni dimensions	Confezione minima Minimum package	m³	pezzi pallet pcs pallet	m³
01 013 027	27	a27 b4	10 27x27x3,9h	0,01	140 60x40x50h	0,12
01 013 033	33	a33 b5	10 33x33x13h	0,01	70 60x40x50h	0,12
01 013 038	38	a37,5 b6	10 38x38x16h	0,02	50 60x40x50h	0,12

Sottocassettone

Superficie opaca / Matt finished
Surface opaque / Matt-Oberfläche



001
terracotta/terracotta colour
couleur terre/farbe terrakotta



005
antracite/anthracite
anthracite/anthrazitgrau

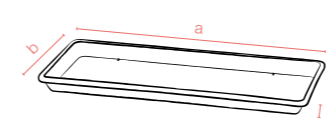

codice senza colore code without colour	Cm	dimensioni dimensions	Confezione minima Minimum package	m³	pezzi pallet pcs pallet	m³
01 014 060	60	a56 b28 c4,3	5 56x28x7h	0,01	60 60x40x50h	0,12
01 014 080	80	a75 b32 c5,1	5 75x33x9h	0,02	285 80x120x115h	1,10
01 014 100	100	a95 b35 c5,2	5 95x35x11h	0,03	160 80x120x115h	1,10



022
bianco/white
blanc/weiß



403
corda/cord
corde/seil



406
bruno/brown
brun/braun



408
cacao/cocoa
cacao/kakao



414
fog grey/fog grey
brouillard gris/Nebel grau



018
ciclamino/cyclamen
cyclamen/zyklamfarbe



019
lilla/lilac
lilas/lila



404
cedro/cedar
cèdre/zeder

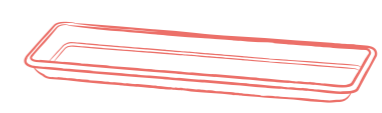

Sottocassetta
pagina 166

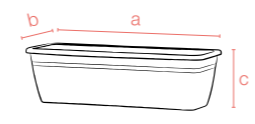

codice senza colore code without colour	Cm	dimensioni dimensions	litri liters	Confezione minima Minimum package	m ³	pezzi pallet pcs pallet	m ³	accessori accessories
01 004 040	40	a40 b17 c14,5	6	10 40x17x30h	0,02	700 80x120x115h	1,10	
01 004 050	50	a50 b17 c14,5	8	10 50x17x30h	0,02	450 80x120x118h	1,13	
01 004 060	60	a60 b17 c14,5	10	10 60x17x30h	0,03	450 80x120x115h	1,10	
01 004 080	80	a80 b17 c14,5	12	10 80x17x30h	0,04	240 80x120x105h	1,01	



Superficie opaca
Matt finished
Surface opaque
Matt-Oberfläche

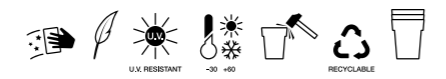

Cassetta mare colour



Superficie opaca
Matt finished
Surface opaque
Matt-Oberfläche



Cassetta mare classic



001

terracotta/terracotta colour
couleur terre/farbe terrakotta



005

antracite/anthracite
anthracite/anthrazitgrau



002

verde/green
vert/grün



Sottocassetta
pagina 166

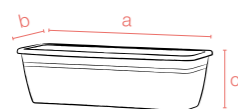

codice senza colore code without colour	Cm	dimensioni dimensions	litri liters	Confezione minima Minimum package	pezzi pallet pcs pallet	accessori accessories
01 004 040	40	a40 b17 c14,5	6	10 40x17x30h	700	80x120x115h 1,10
01 004 050	50	a50 b17 c14,5	8	10 50x17x30h	450	80x120x118h 1,13
01 004 060	60	a60 b17 c14,5	10	10 60x17x30h	450	80x120x115h 1,10
01 004 080	80	a80 b17 c14,5	12	10 80x17x30h	240	80x120x106h 1,02



supporto mare
pagina 165



100 cm

fino a / up to / jusqu'à les / bis



001

terracotta/terracotta colour
couleur terre/farbe terrakotta



005

antracite/anthracite
anthracite/anthrazitgrau



406

bruno/brown
brun/braun

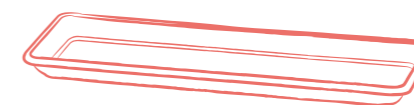

Sottocassetta
pagina 166

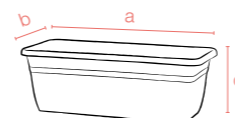

codice senza colore code without colour	Cm	dimensioni dimensions	litri liters	Confezione minima Minimum package	pezzi pallet pcs pallet	accessori accessories
01 104 040	40	a40 b18 c14	10	5 40x18x22h	480	80x120x106h 1,08
01 104 060	60	a60 b18 c14	15	5 60x18x22h	320	80x120x106h 1,08
01 104 080	80	a80 b18 c14	20	5 80x18x22h	240	80x120x106h 1,08
01 104 100	100	a100 b18 c14	25	5 100x18x22h	160	80x120x106h 1,08

Cassetta Tirol

Superficie opaca / Matt finished
Surface opaque / Matt-Oberfläche

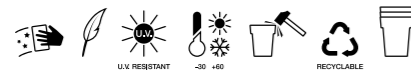

“La cassetta Tirol contiene davvero tanta terra e riesco a coltivare molte varietà di piante.”
“The balcony box Tirol really contains a lot of compost so I can cultivate many plant varieties”
“La jardinière Tirol contient beaucoup de terre et je peux cultiver toute variété de plantes”
“Der Blumenkasten Tirol enthält wirklich viel Erde und ich kann viele Pflanzensorten züchten.”

Linda



001

terracotta/terracotta colour
couleur terre/farbe terrakotta



005

antracite/anthracite
anthracite/anthrazitgrau

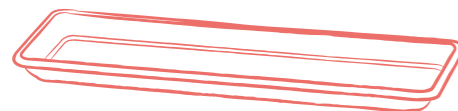

Sottocassetta
pagina 165

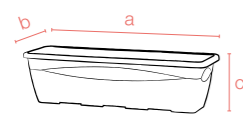

codice senza colore code without colour	Cm	dimensioni dimensions	litri liters	Confezione minima Minimum package	m ³	pezzi pallet pcs pallet	m ³
01 006 040	40	a40 b20 c16	8	40	10 40x20x31h	0,02	720 80x120x118h 1,13
01 006 050	50	a50 b20 c16	10,5	50	10 50x20x31h	0,03	540 80x120x118h 1,13
01 006 060	60	a60 b20 c16	13	60	10 60x20x31h	0,03	480 80x120x115h 1,10

Cassetta Panorama kit

Superficie opaca / Matt finished
Surface opaque / Matt-Oberfläche

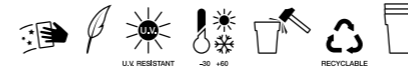

Disponibile in sei colori
Six colors available
Six couleurs disponibles
Sechs Farben erhältlich



404

cedro/cedar
cèdre/zeder



riserva d'acqua
Self-watering system
réserve d'eau
Wasserspeicher



Il supporto in ferro è regolabile in 8 posizioni
Iron support 8 adjustable positions
Support en fer 8 positions réglables
Eisenhalterung auf 8 Positionen verstellbar

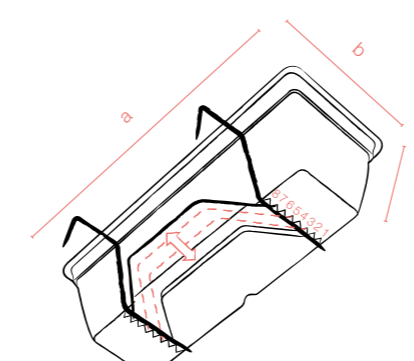

codice senza colore code without colour	Cm	dimensioni dimensions	litri liters	Confezione minima Minimum package	m ³
001 005 406 410 404 408	50	a50 b26 c16	20,8	66 60x80x115h	0,5



100 cm
fino a / up to / jusqu'à les / bis

Superficie opaca
Matt finished
Surface opaque
Matt-Oberfläche



Cassetta Portofino



001

terracotta/terracotta colour
couleur terre/farbe terrakotta



005

antracite/anthracite
anthracite/anthrazitgrau



406

bruno/brown
brun/braun



misure 80 - 100
sizes 80 - 100

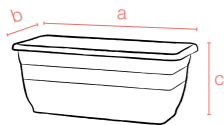

codice senza colore code without colour	Cm	dimensioni dimensions			litri liters	Confezione minima Minimum package	m ³	pezzi pallet pcs pallet	m ³
01 105 040	40	a 40	b 20	c 16,5	13	5 40x20x32h	0,02	240 80x120x110h	1,06
01 105 060	60	a 60	b 20	c 16,5	20	5 60x20x32h	0,03	160 80x120x110h	1,06
01 105 080	80	a 80	b 20	c 16,5	26	5 80x20x32h	0,05	120 80x120x110h	1,06
01 105 100	100	a 100	b 20	c 16,5	33	5 100x20x32h	0,06	80 80x120x110h	1,06

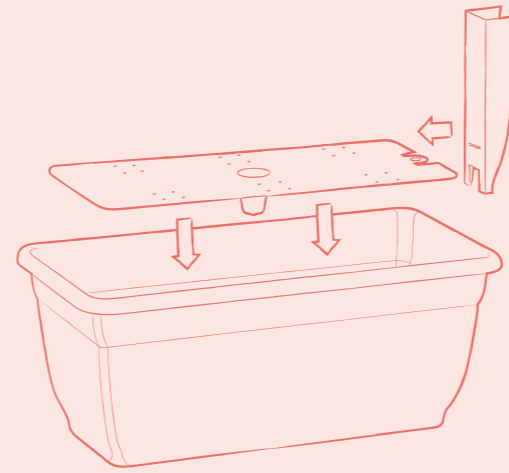

diffusione
dell'acqua per osmosi
water diffusion
through osmosis's
effect
diffusion de l'eau par
osmose
Wasserdiffusion durch
Osmose

beccuccio per
inserimento dell'acqua
spout for water insertion
bec pour l'introduction
de l'eau
Füllschacht zur
Wasserversorgung

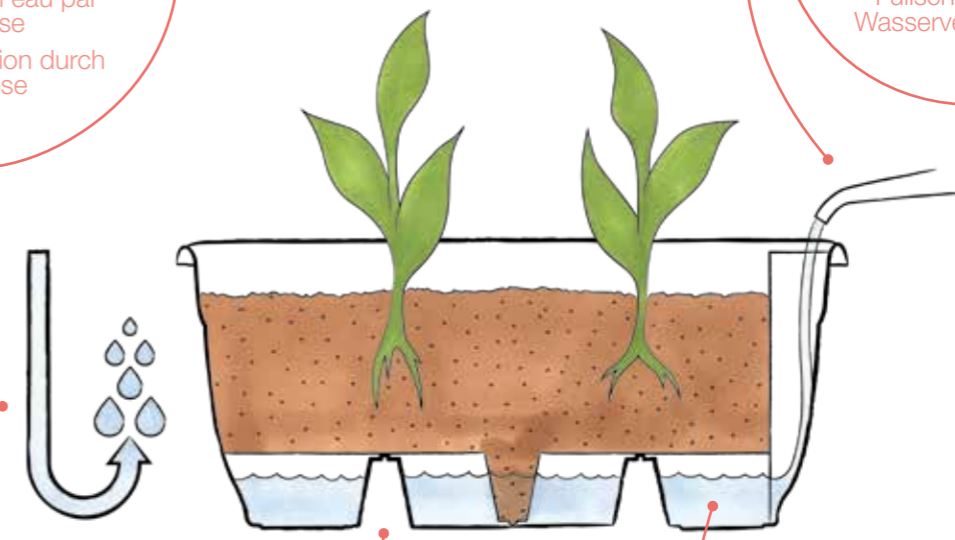

foro di drenaggio per
l'acqua in eccesso
drainage bore for
water's excess
trou de drainage pour
l'eau en excès
Entwässerungsloch

riserva d'acqua
Self-watering
system
réserve d'eau
Wasserspeicher

Cassetta Coste

Superficie opaca / Matt finished
Surface opaque / Matt-Oberfläche



001
terracotta/terracotta colour
couleur terre/farbe terrakotta



005
antracite/anthracite
anthracite/anthrazitgrau

diffusione dell'acqua per osmosi
water diffusion through osmosis's effect
diffusion de l'eau par osmose
Wasserdiffusion durch Osmose

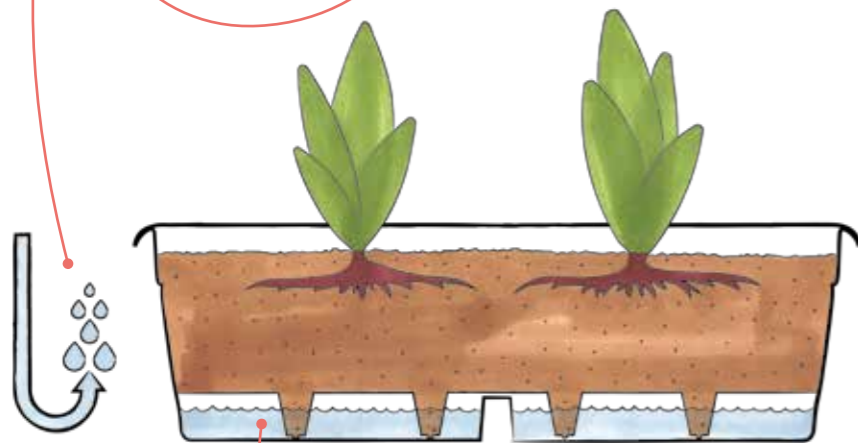

riserva d'acqua
Self-watering system
réserve d'eau
Wasserspeicher

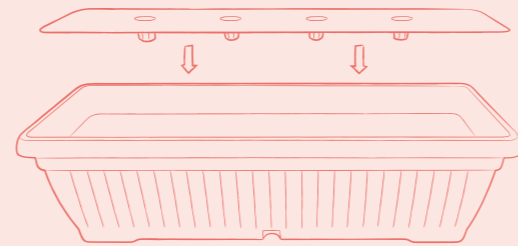

supporto coste
pagina 165

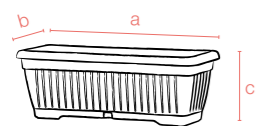

codice senza colore code without colour	Cm	dimensioni dimensions	litri liters	Confezione minima Minimum package	pezzi pallet pcs pallet	accessori accessories
01 005 040	40	a40 b20 c17,3	8	10 40x20x43h	0,03	360 80x120x115h 1,10
01 005 050	50	a50 b20 c17,3	10,5	10 50x20x43h	0,04	270 80x120x115h 1,10
01 005 060	60	a60 b20 c17,3	13	10 60x20x43h	0,05	240 80x120x118h 1,13

kit balcone Coste

Superficie opaca / Matt finished
Surface opaque / Matt-Oberfläche

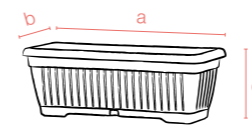
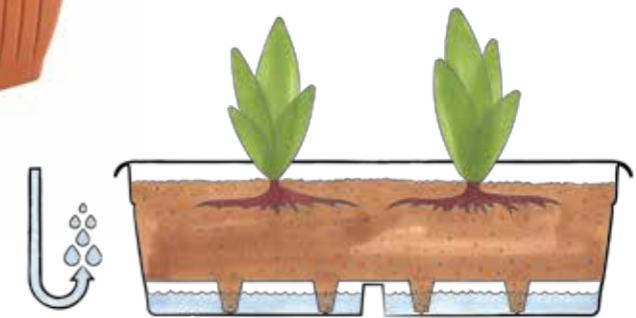

codice senza colore code without colour	Cm	dimensioni dimensions	Confezione minima Minimum package	pezzi pallet pcs pallet
01 016 040	40	a40 b20 c17,3	104 80x60x115h	0,55
01 016 050	50	a50 b20 c17,3	78 80x60x115h	0,55
01 016 060	60	a60 b20 c17,3	78 80x60x115h	0,55

supporto Coste



codice senza colore code without colour	Cm	Confezione minima Minimum package
10 901 040	40	10 40x28x30h
10 901 050	50	10 50x28x30h
10 901 060	60	10 60x28x30h

supporto Mare

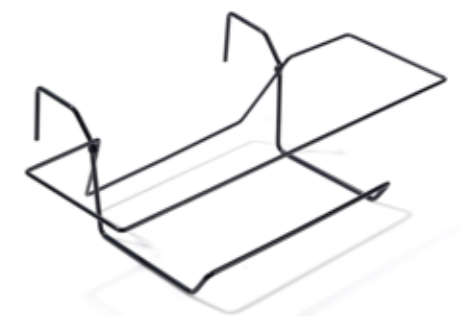

codice senza colore code without colour	Cm	Confezione minima Minimum package
10 900 040	40	10 46x30x24h
10 900 050	50	10 56x30x24h
10 900 060	60	10 66x30x24h
10 900 080	80	10 86x30x24h



Superficie opaca
Matt finished
Surface opaque
Matt-Oberfläche



Superficie opaca
Matt finished
Surface opaque
Matt-Oberfläche



Sottocassetta colour



022

bianco/white
blanc/weiß



403

corda/cord
corde/seil



406

bruno/brown
brun/braun



408

cacao/cocoa
cacao/kakao



414

fog grey/fog grey
brouillard gris/Nebel grau



018

ciclamino/cyclamen
cyclamen/zyklamfarbe



019

lilla/lilac
lilas/lila



404

cedro/cedar
cèdre/zeder

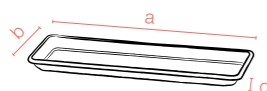

codice senza colore code without colour	Cm	dimensioni dimensions	litri liters	Confezione minima Minimum package	m ³	pezzi pallet pcs pallet	m ³
01 012 040	40	a38 b19 c3,2	2	10 38x19x10h	0,01	240	60x40x50h 0,12
01 012 050	50	a48 b19 c3,2	3	10 48x19x10h	0,01	160	60x40x50h 0,12
01 012 060	60	a58 b19 c3,2	5	10 58x19x10h	0,01	160	60x40x50h 0,12
01 012 080	80	a78 b19 c3,2	8	10 78x19x10h	0,02	1080	80x120x115h 1,10
01 012 100	100	a98 b19 c3,2	10	10 98x19x10h	0,02	720	80x115x115h 1,06

Sottocassetta classic



001

terracotta/terracotta colour
couleur terre/farbe terrakotta



005

antracite/anthracite
anthracite/anthrazitgrau



002

verde/green
vert/grün

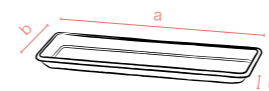

codice senza colore code without colour	Cm	dimensioni dimensions	litri liters	Confezione minima Minimum package	m ³	pezzi pallet pcs pallet	m ³
01 012 040	40	a38 b19 c3,2	2	10 38x19x10h	0,01	240	60x40x50h 0,12
01 012 050	50	a48 b19 c3,2	3	10 48x19x10h	0,01	160	60x40x50h 0,12
01 012 060	60	a58 b19 c3,2	5	10 58x19x10h	0,01	160	60x40x50h 0,12
01 012 080	80	a78 b19 c3,2	8	10 78x19x10h	0,02	1080	80x120x115h 1,10
01 012 100	100	a98 b19 c3,2	10	10 98x19x10h	0,02	720	80x115x115h 1,06



Contattaci per ulteriori informazioni
 Contact us for more information
 Contactez-nous pour plus d'informations
 Kontaktieren Sie uns für mehr Informationen

Espositore Hydral

L'espositore è adatto per contenere i nostri articoli HYDRAL nelle seguenti misure e quantità:

The Display is suitable to hold our HYDRAL in the following sizes and quantities:

Le présentoir est apte à contenir nos articles HYDRAL dans les tailles et quantités suivantes:

Der Präsentationsständer ist für unseren Artikel HYDRAL geeignet und kann folgende Größen und Mengen enthalten:

codice senza colore code without colour	descrizione	quantità totale consigliata	minimo vendita per colore
28 107 018	hydral 18	20	20
28 107 023	hydral 23	20	10
28 107 028	hydral 28	20	10
28 107 033	hydral 33	20	10
28 107 038	hydral 38	20	8



Display



Contattaci per ulteriori informazioni
 Contact us for more information
 Contactez-nous pour plus d'informations
 Kontaktieren Sie uns für mehr Informationen

Espositore cilindri e sottovasi

L'espositore è adatto per contenere i nostri articoli CILINDRO INIEZIONE e SOTTOVASO INIEZIONE nelle seguenti misure e quantità:

The Display is suitable to hold our ITEMS CYLINDER INJECTION AND SAUCER INJECTION in the following sizes and quantities:

Le présentoir est apte à contenir nos articles CYLINDRE INJECTÉ et SOUCOUPES dans les tailles et quantités suivantes:

Der Präsentationsständer ist für unseren Artikel INJEKTION ZYLINDER TOPF und UNTERSETZER RUND in den folgenden Größen und Mengen als Behälter geeignet:

codice senza colore code without colour	descrizione	quantità totale consigliata	minimo vendita per colore
01 001 020	Cilindro cm 20	10	20
01 001 025	Cilindro cm 25	10	10
01 001 030	Cilindro cm 30	10	10
01 001 035	Cilindro cm 35	10	10
01 001 040	Cilindro cm 40	5	10

codice senza colore code without colour	descrizione	quantità totale consigliata	minimo vendita per colore
01 011 018	Sottovaso cm 18	10	100
01 011 022	Sottovaso cm 22	10	50
01 011 026	Sottovaso cm 26	10	50
01 011 030	Sottovaso cm 30	10	25
01 011 035	Sottovaso cm 35	5	25



Contattaci per ulteriori informazioni
 Contact us for more information
 Contactez-nous pour plus d'informations
 Kontaktieren Sie uns für mehr Informationen

Espositore cassette e sottocassette

L'espositore è adatto per contenere le CASSETTE e LE SOTTOCASSETTE INIEZIONE nelle seguenti misure e quantità:

The Display is suitable to contain our items BALCONY BOXES INJECTION AND SAUCER INJECTION in the following sizes and quantities:

Le présentoir est apte à contenir nos articles JARDINIÈRE et SOUCOUBE JARDINIÈRE INJECTÉ dans les tailles et quantités suivantes:

Der Präsentationsständer ist für unseren Artikel BALKONKASTEN und UNTERSETZER BALKONKASTEN in folgenden Größen und Mengen als Behälter geeignet:

codice senza colore code without colour	descrizione	quantità totale consigliata	minimo vendita per colore
01 004 040	Cassetta cm 40	15	10
01 004 050	Cassetta cm 50	15	10
01 004 060	Cassetta cm 60	15	10
01 004 080	Cassetta cm 80	15	10

codice senza colore code without colour	descrizione	quantità totale consigliata	minimo vendita per colore
01 012 040	Sottocassetta cm 40	15	10
01 012 050	Sottocassetta cm 50	15	10
01 012060	Sottocassetta cm 60	15	10
01 012 080	Sottocassetta cm 80	15	10



Espositore cilindri

L'espositore è adatto per contenere il nostro articolo CILINDRO INIEZIONE nelle seguenti misure e quantità:

The Display is suitable to hold our article CYLINDER INJECTION in the following sizes and quantities:

Le présentoir est apte à contenir notre article CYLINDRE INJECTÉ dans les tailles et quantités suivantes:

Der Präsentationsständer ist für unseren Artikel INJEKTION ZYLINDER TOPF in den folgenden Größen und Mengen als Behälter geeignet:

Contattaci per ulteriori informazioni
 Contact us for more information
 Contactez-nous pour plus d'informations
 Kontaktieren Sie uns für mehr Informationen

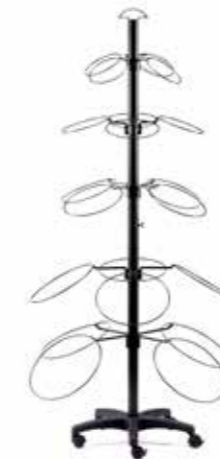

codice senza colore code without colour	descrizione	quantità totale consigliata	minimo vendita per colore
01 001 020	Cilindro cm 20	40	20
01 001 025	Cilindro cm 25	40	10
01 001 030	Cilindro cm 30	40	10
01 001 035	Cilindro cm 35	40	10
01 001 040	Cilindro cm 40	40	10



Espositore sottovasi

L'espositore è adatto per contenere il nostro articolo SOTTOVASO ROTONDO INIEZIONE nelle seguenti misure e quantità:

The Display is suitable to hold our article ROUND SAUCER INJECTION in the following sizes and quantities:

Le présentoir est apte à contenir notre article SOUCOUPE RONDE INJECTÉE dans les tailles et quantités suivantes:

Der Präsentationsständer ist für unseren Artikel INJEKTION UNTERSETZER RUND in den folgenden Größen und Mengen als Behälter geeignet:

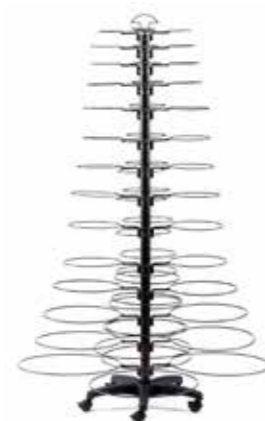

Contattaci per ulteriori informazioni
Contact us for more information
Contactez-nous pour plus d'informations
Kontaktieren Sie uns für mehr Informationen

codice senza colore code without colour	descrizione	quantità totale consigliata	minimo vendita per colore
01 011 012	Sottovaso cm 12	100	100
01 011 014	Sottovaso cm 14	100	100
01 011 016	Sottovaso cm 16	100	100
01 011 018	Sottovaso cm 18	50	100
01 011 020	Sottovaso cm 20	50	50
01 011 022	Sottovaso cm 22	50	50
01 011 024	Sottovaso cm 24	50	50
01 011 026	Sottovaso cm 26	50	50
01 011 028	Sottovaso cm 28	50	50
01 011 030	Sottovaso cm 30	50	25
01 011 035	Sottovaso cm 35	50	25
01 011 040	Sottovaso cm 40	50	25
01 011 045	Sottovaso cm 45	50	25
01 011 052	Sottovaso cm 52	50	25

Contattaci per ulteriori informazioni
Contact us for more information
Contactez-nous pour plus d'informations
Kontaktieren Sie uns für mehr Informationen

Espositore Hydral Teraguard

L'espositore è adatto per contenere i nostri articoli HYDRAL nelle seguenti misure e quantità:

The Display is suitable to hold our HYDRAL in the following sizes and quantities:

Le présentoir est apte à contenir nos articles HYDRAL dans les tailles et quantités suivantes:

Der Präsentationsständer ist für unseren Artikel HYDRAL geeignet und kann folgende Größen und Mengen enthalten:

codice senza colore code without colour	descrizione	quantità totale consigliata	minimo vendita per colore
28 107 018	hydral 18	20	20
28 107 023	hydral 23	20	10
28 107 028	hydral 28	20	10
28 107 033	hydral 33	20	10
28 107 038	hydral 38	20	8



SELF WATERING

display kit balcone **Mare** 1 pz

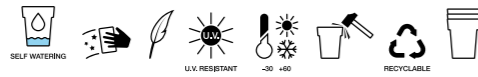

022
bianco/white
blanc/weiß

403
corda/cord
corde/seil

406
bruno/brown
brun/braun

408
cacao/cocoa
cacao/kakao



018
ciclaminò/cyclamen
cyclamen/zyklamfarbe

019
lilla/lilac
lilas/lila

404
cedro/cedar
cèdre/zeder



001
terracotta/terracotta colour
couleur terre/farbe terrakotta

005
antracite/anthracite
anthracite/anthrazitgrau

codice senza colore code without colour	Cm	dimensioni dimensions	pezzi pallet pcs pallet	m ³
01 015 040 022 403 406 408 018 019 404 001 005	40	a40 b17 c14,5	48	80x120x115h 1,10
01 015 050 022 403 406 408 018 019 404 001 005	50	a50 b17 c14,5	42	80x120x115h 1,10
01 015 060 022 403 406 408 018 019 404 001 005	60	a60 b17 c14,5	35	80x120x115h 1,10
01 015 080 403 406 408 001 005	80	a80 b17 c14,5	24	80x120x115h 1,10

display kit balcone **Mare** 2 pz

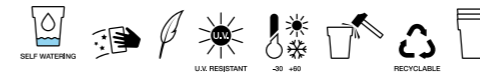

022
bianco/white
blanc/weiß

403
corda/cord
corde/seil

406
bruno/brown
brun/braun

408
cacao/cocoa
cacao/kakao



018
ciclaminò/cyclamen
cyclamen/zyklamfarbe

019
lilla/lilac
lilas/lila

404
cedro/cedar
cèdre/zeder



001
terracotta/terracotta colour
couleur terre/farbe terrakotta

005
antracite/anthracite
anthracite/anthrazitgrau

codice senza colore code without colour	Cm	dimensioni dimensions	pezzi pallet pcs pallet	m ³
01 019 040 022 403 406 408 018 019 404 001 005	40	a40 b17 c14,5	40	80x120x115h 1,10
01 019 050 022 403 406 408 018 019 404 001 005	50	a50 b17 c14,5	35	80x120x115h 1,10
01 019 060 022 403 406 408 018 019 404 001 005	60	a60 b17 c14,5	25	80x120x115h 1,10
01 019 080 403 406 408 001 005	80	a80 b17 c14,5	18	80x120x115h 1,10



T-BASKET



T-Basket



T-Basket Big



ideale per contenere
3 vasi da 14 cm
Ideal for containing
3 pots of 14 cms
Idéal pour contenir 3
vases à 14 cm
Ideal um 3 Vasen à
14cm zu fassen

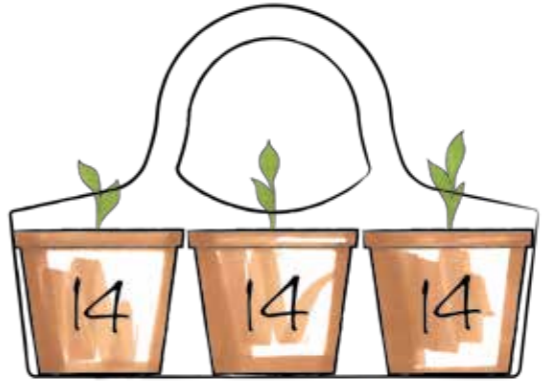

Linea Flortec
pagina 183



022
bianco/white
blanc/weiß



010
rosso/red
rouge/rot



402
lilyum/lilyum
lilyum/lilyum



404
cedro/cedar
cèdre/zeder



406
bruno/brown
brun/braun



Superficie opaca
Matt finished
Surface opaque
Matt-Oberfläche



T-Basket

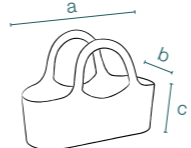

codice senza colore code without colour	Cm	dimensioni dimensions	pezzi pallet pcs pallet	m ³
BOX 1 COLOUR	26 101 000	a43 b18 c31	10	44x18x55h 0,043
BIG BOX	26 101 000	a48 b18 c31	78	57x50x103h 0,293



022
bianco/white
blanc/weiß



010
rosso/red
rouge/rot



402
lilyum/lilyum
lilyum/lilyum



404
cedro/cedar
cèdre/zeder

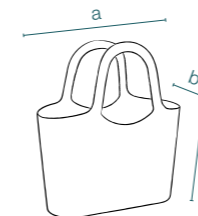

codice senza colore code without colour	Cm	dimensioni dimensions	pezzi pallet pcs pallet	m ³
BOX 1 COLOUR	26 102 000	a48 b18 c51	6	44x18x55h 0,043
BIG BOX	26 102 000	a48 b18 c51	63	57x50x103h 0,293



Superficie opaca
Matt finished
Surface opaque
Matt-Oberfläche



T-Basket big



linea
FLOORTEC



Norma



Container



Crisa



Basso

vaso Norma



001

terracotta/terracotta colour
couleur terre/farbe terrakotta



003

nero/black
noir/schwarz

A richiesta sono disponibili altri colori
Further colours are available on demand
D'autres couleurs sont disponibles sur demande
Weiteren Farben sind auf Anforderung vorrätig



010

rosso/red
rouge/rot



013

giallo/yellow
jaune/gelb



015

azzurro/light blue
azur/hellblau



016

arancio/orange
orange/orange



018

ciclamino/cyclamen
cyclamen/zyklamfarbe



019

lilla/lilac
lilas/lila



404

cedro/cedar
cèdre/zeder

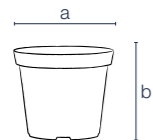

codice senza colore code without colour	Cm	colori colour	colori a richiesta colours on request	dimensioni dimensions	litri liters	pz/conf pcs/pack	Pcs Pit
03 300 008	8	001 003	010 013 015 016 018 019 404	a8 b6,8	0,2	2275	36400
03 300 010	10	001 003	010 013 015 016 018 019 404	a10 b7,7	0,38	1610	25760
03 300 011	11	001 003	010 013 015 016 018 019 404	a11 b8,8	0,53	1188	19008
03 300 012	12	001 003	010 013 015 016 018 019 404	a12 b10	0,72	915	14640
03 300 013	13	001 003	010 013 015 016 018 019 404	a13 b11	0,94	840	13440
03 300 014	14	001 003	010 013 015 016 018 019 404	a14 b12	1,25	671	10736
03 300 015	15	001 003	010 013 015 016 018 019 404	a15 b13	1,51	495	7920
03 300 016	16	001 003	010 013 015 016 018 019 404	a16 b12,2	1,79	360	5760
03 300 018	18	001 003	010 013 015 016 018 019 404	a18 b13,6	2,61	300	4800

Flortec Special Packaging



We can provide to our customers a wide range of **special packaging**.

Nous pouvons vous fournir une large gamme d'**emballages spéciaux**.

Lieferung in **Sonderverpackungen** möglich.

Siamo in grado di fornirvi un'ampia gamma di **imballi speciali**.

vaso **Container**



001

terracotta/terracotta colour
couleur terre/farbe terrakotta



003

nero/black
noir/schwarz

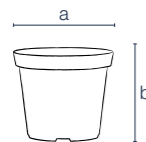

codice senza colore code without colour	Cm	colori colour	colori a richiesta colours on request	dimensioni dimensions	litri liters	pz/conf pcs/pack	Pcs Pit
03 301 015	15	001 003		a15 b13	1,63	423	6768
03 301 019	19	001 003	010 013 015 016 018 019 404	a19 b17,4	3,43	186	2976

vaso **Basso**



001

terracotta/terracotta colour
couleur terre/farbe terrakotta



003

nero/black
noir/schwarz

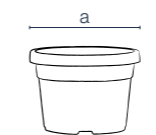

codice senza colore code without colour	Cm	colori colour	dimensioni dimensions	litri liters	pz/conf pcs/pack	Pcs Pit
03 303 017	17	001 003	a17 b12	1,74	192	3072

vaso **Crisa**



001

terracotta/terracotta colour
couleur terre/farbe terrakotta

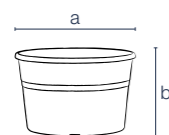

codice senza colore code without colour	Cm	colori colour	dimensioni dimensions	litri liters	pz/conf pcs/pack	Pcs Pit
03 304 022	22	001	a22 b15	3,31	140	2240

Gabbia verde



002

verde/green
vert/grün

codice senza colore code without colour	Cm	colori colour	dimensioni dimensions	pz/conf pcs/pack	Pcs Pit
03 302 014	14	002	a14 b22	240	4800

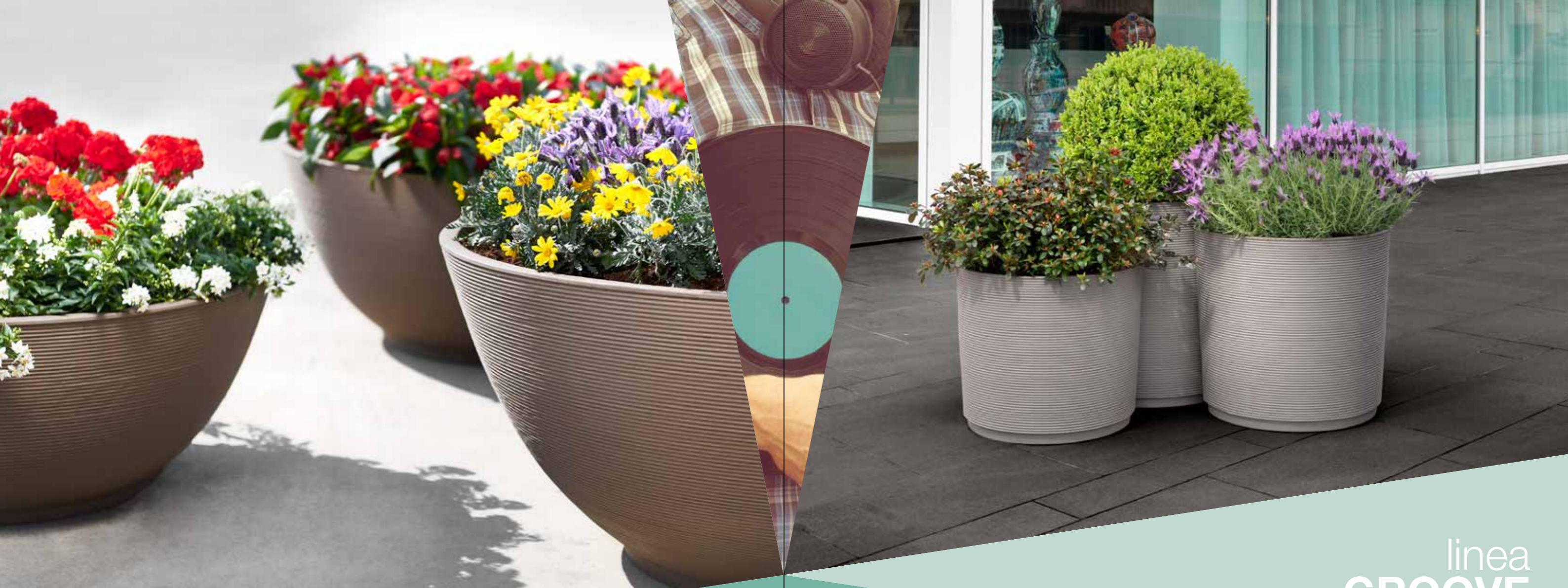

linea
GROOVE



Arena



Indy



Pixel



Sottovaso Pixel



Sottovaso Indy



Ring



Urban



Arena, Indy, Pixel, Ring e Urban sono accomunati da una splendida finitura.

Arena, Indy, Pixel, Ring and Urban have a stunning finish in common.

Arena, Indy, Pixel, Ring et Urban ont une superbe finition en commun.

Arena, Indy, Pixel, Ring und Urban haben alle eine ganz besondere Oberfläche



043

bianco/white
blanc/weiß



201

cappuccino/cappuccino
cappuccino/cappuccino



235

beton/beton
beton/beton

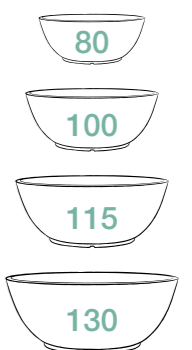
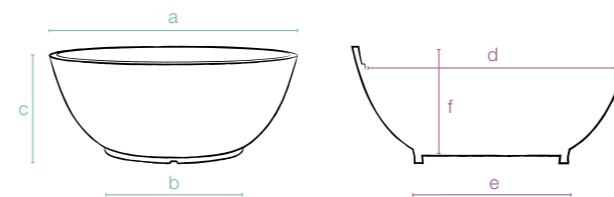

codice senza colore code without colour	Cm	dimensioni esterne external dimensions			dimensioni interne internal dimensions			litri liters	Confezione minima Minimum package	m ³	pezzi pallet pcs pallet	m ³
29 476 080	80	a80	b44	c32	d68,5	e43,5	f32	95	1 80x80x32h	0,20	8	80x80x113h 0,72
29 476 100	100	a100	b55	c40	d89	e54	f39	210	1 100x100x40h	0,40	7	100x100x116h 1,16
29 476 115	115	a115	b65	c46	d104	e63	f45	320	1 115x115x46h	0,61	6	115x115x116h 1,53
29 476 130	130	a130	b73	c52	d118	e71	f50	460	1 130x130x52h	0,88	5	130x130x118h 1,99

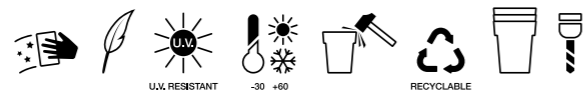

Arena

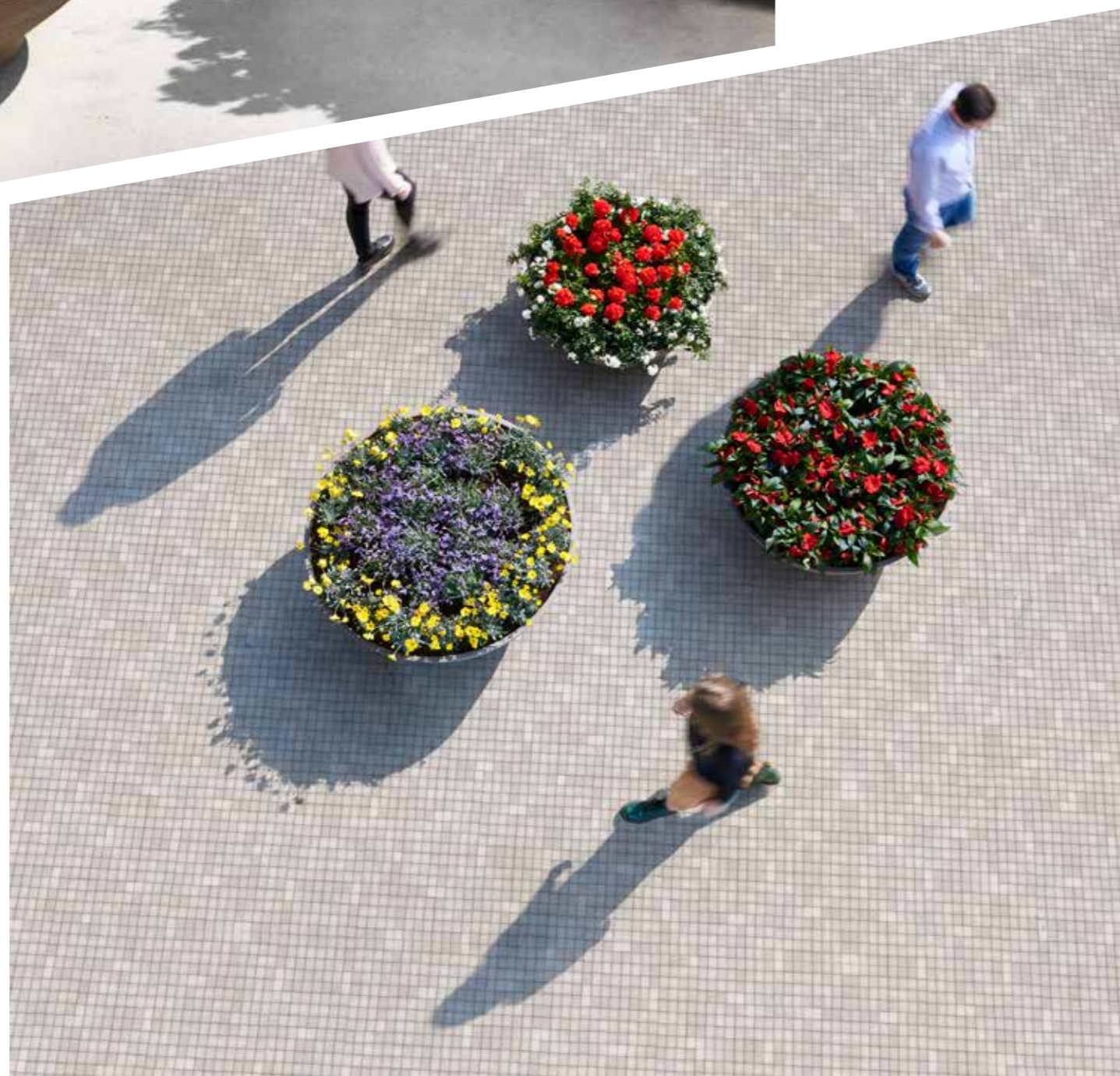

032

antracite/anthracite
anthracite/anthrazitgrau



039

bronzo/bronze
bronze/bronze



030

anticato/light brown
marron clair/hellbraun

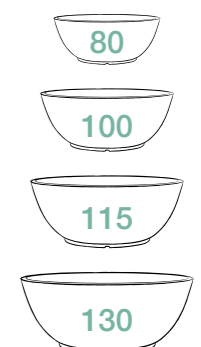
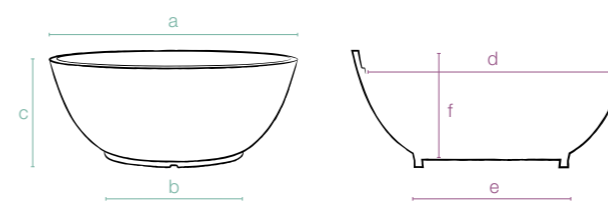

codice senza colore code without colour	Cm	dimensioni esterne external dimensions			dimensioni interne internal dimensions			litri liters	Confezione minima Minimum package	m³	pezzi pallet pcs pallet	m³
29 476 080	80	a80	b44	c32	d68,5	e43,5	f32	95	1 80x80x32h	0,20	8	80x80x113h 0,72
29 476 100	100	a100	b55	c40	d89	e54	f39	210	1 100x100x40h	0,40	7	100x100x116h 1,16
29 476 115	115	a115	b65	c46	d104	e63	f45	320	1 115x115x46h	0,61	6	115x115x116h 1,53
29 476 130	130	a130	b73	c52	d118	e71	f50	460	1 130x130x52h	0,88	5	130x130x118h 1,99

Creare una riserva d'acqua in pochi semplici passaggi:

How to create a Self-watering system in a few simple steps:

Comment créer une réserve d'eau en quelques étapes simples :

In wenigen einfachen Schritten einen Wasserspeicher anlegen:

1.

Con il trapano fai un foro in un punto qualsiasi nella parte bassa del vaso.

Use a drill to make a hole wherever you like towards the bottom of the pot.

Faites un trou avec une perceuse dans un point quelconque de la partie basse du pot.

Mit der Bohrmaschine eine Bohrung an einem beliebigen Punkt des unteren Bereichs des Pflanztrogs ausführen.

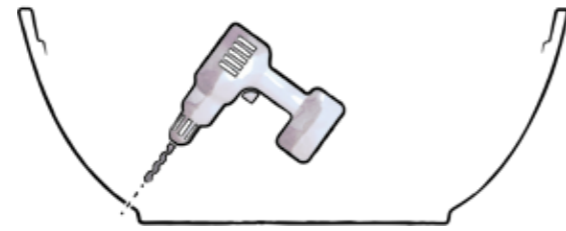

2.

Inserisci uno strato di argilla sul fondo

Add a layer of clay pebbles on the bottom

Ajouter une couche d'argile sur le fond

Eine Schicht Tongranulat am Boden einschichten



3.

Poi stendi il tessuto non tessuto

Then spread out the nonwoven fabric

Étirer le tissu non tissé

Dann das Vlies auslegen



4.

Riempi il vaso di terra

Fill the pot with topsoil

Remplissez le pot avec de la terre

Den Pflanztrog mit Erde auffüllen



5.

Infine interra la pianta.

Eventually, place your plant in soil.

Enfin, enterrez la plante.

Nun die Pflanze einsetzen.

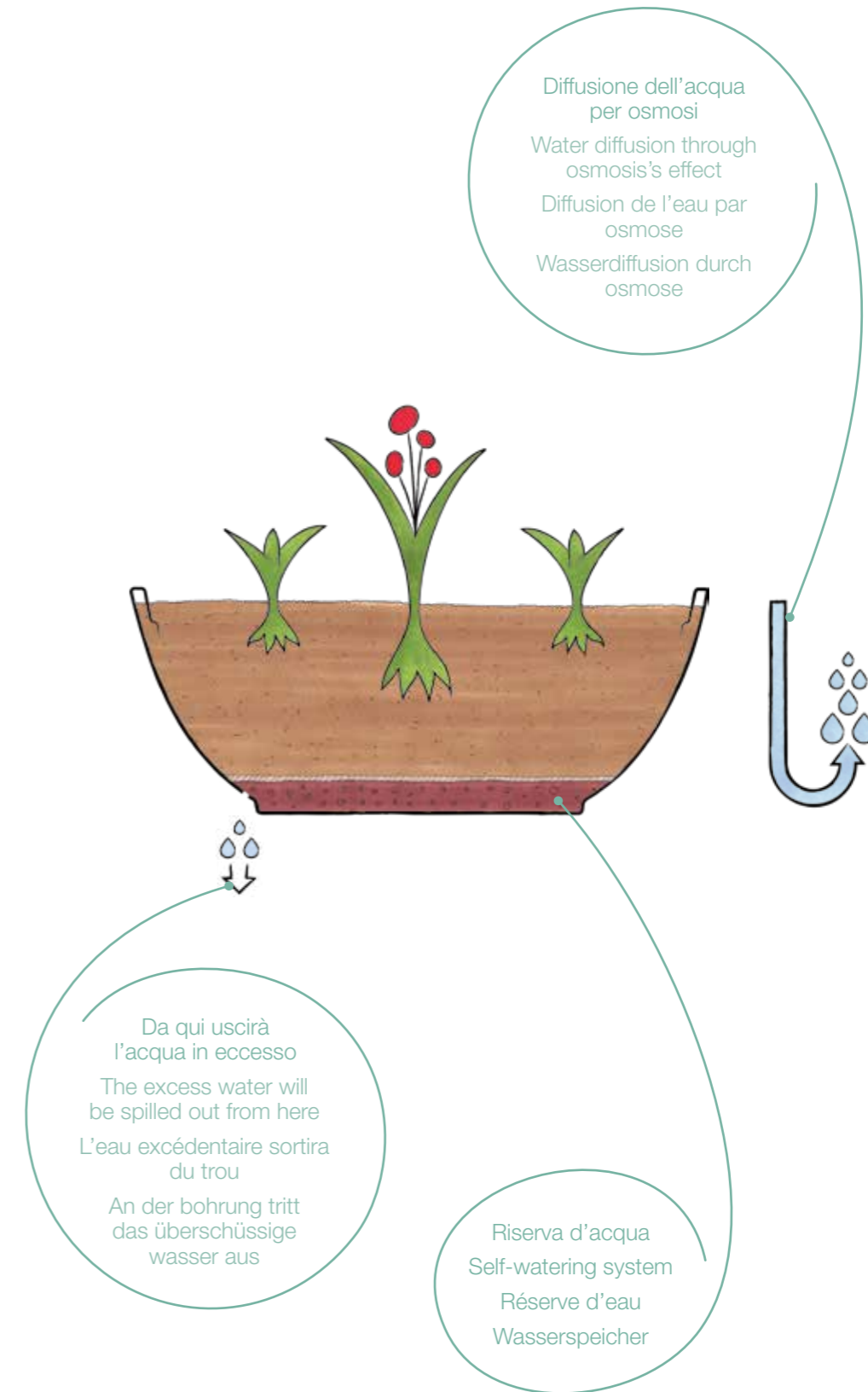



043
bianco/white
blanc/weiß



201
cappuccino/cappuccino
cappuccino/cappuccino



235
beton/beton
beton/beton



032
antracite/anthracite
anthracite/anthrazitgrau



039
bronzo/bronze
bronze/bronze

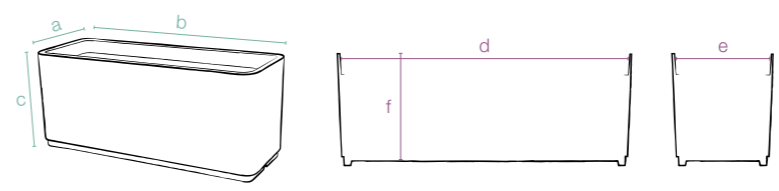

Indy

codice senza colore code without colour	Cm	dimensioni esterne external dimensions			dimensioni interne internal dimensions			litri liters	Confezione minima Minimum package	m ³	pezzi pallet pcs pallet	m ³
29 474 098	98	a38,2	b98,2	c39,8	d89	e29,5	f38,5	131	2 76x38,5x99h	0,29	10 80x120x210h	2,0

Vorresti arredare uno spazio senza l'utilizzo di piante? Con Indy Kit ti proponiamo un'ottima soluzione!

Would you like to decorate an area without using plants? With Indy Kit we suggest an excellent solution!

Souhaitez vous aménager un espace sans utiliser de plantes? Avec Indy Kit nous vous proposons une excellente solution!

Möchten Sie einen Bereich ohne Pflanzen arrangieren? Indy Kit ist die optimale Lösung!



Indy

Cod. 29 474 098

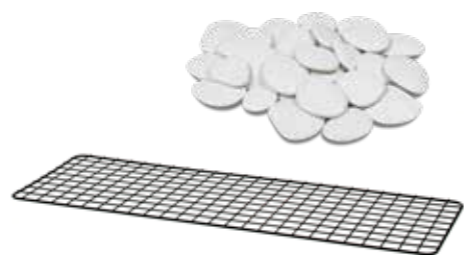

Griglia e sassi

Grid and stones
Grille et cailloux
Gitter und Steine

Cod. 10 923 098 000



Indy kit

I rinforzi sono inclusi e vengono fissati ad incastro.
The brackets are included and are fitted into.

Die Distanzhalter sind eingeschlossen und mit Clip-Funktion zusammenbefestigt
Les espaceurs sont inclus et emboîtés



Creare una riserva d'acqua in pochi semplici passaggi:

How to create a Self-watering system in a few simple steps:

Comment créer une réserve d'eau en quelques étapes simples :

In wenigen einfachen Schritten einen Wasserspeicher anlegen:

1.

Con il trapano fai un foro sull'apposito rialzo
Use a drill to place a hole in the specific raised part of the pot

Utilisez une perceuse pour faire un trou sur l'augmentation appropriée

Mit der Bohrmaschine eine Bohrung an der entsprechenden Erhöhung ausführen

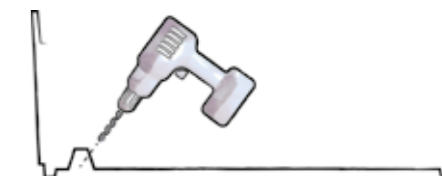

2.

Inserisci uno strato di argilla sul fondo

Add a layer of clay pebbles on the bottom

Ajouter une couche d'argile sur le fond

Eine Schicht Tongranulat am Boden einschichten



3.

Poi stendi il tessuto non tessuto

Then spread out the nonwoven fabric

Étirer le tissu non tissé

Dann das Vlies auslegen



4.

Riempi il vaso di terra

Fill the pot with topsoil

Remplissez le pot avec de la terre

Den Pflanztrog mit Erde auffüllen



5.

Infine interra la

Eventually, place

Enfin, enterrez

Nun die Pflanze



your plant in soil.

la plante.

einsetzen.



Da qui uscirà l'acqua in eccesso
The excess water will be spilled out from here
L'eau excédentaire sortira du trou
An der Bohrung tritt das überschüssige Wasser aus





Creare una riserva d'acqua
in pochi semplici passaggi:
pagina 199

How to create a Self-watering
system in a few simple steps:
page 199

Comment créer une réserve
d'eau en quelques étapes
simples: page 199

In wenigen einfachen Schritten
einen Wasserspeicher anlegen:
Seite 199



043
bianco/white
blanc/weiß



201
cappuccino/cappuccino
cappuccino/cappuccino



032
antracite/anthracite
anthracite/anthrazitgrau



039
bronzo/bronze
bronze/bronze



235
beton/beton
beton/beton

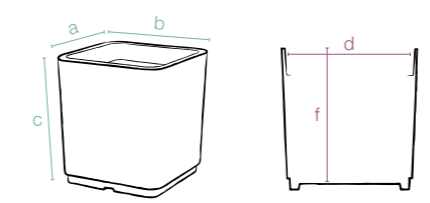

codice senza colore code without colour	Cm	dimensioni esterne external dimensions			dimensioni interne internal dimensions			litri liters	Confezione minima Minimum package	m ³	pezzi pallet pcs pallet	m ³
29 473 038	38	a38,2	b38,2	c39,8	d29,5	e29,5	f38,5	47	2 77x38,5x38,5h	0,11	30 80x120x230h	2,2



Pixel

Vorresti arredare uno spazio senza l'utilizzo di piante? Con Pixel Kit ti proponiamo un'ottima soluzione!

Would you like to decorate an area without using plants? With Pixel Kit we suggest an excellent solution!

Souhaitez vous aménager un espace sans utiliser de plantes? Avec Pixel Kit nous vous proposons une excellente solution!

Möchten Sie einen Bereich ohne Pflanzen arrangieren? Pixel Kit ist die optimale Lösung!



Pixel

Cod. 29 473 038

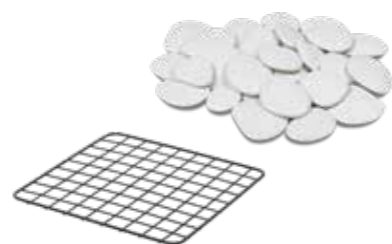

Griglia e sassi

Grid and stones
Grille et cailloux
Gitter und Steine



Cod. 10 923 038 000



Pixel kit



Sottovaso Indy

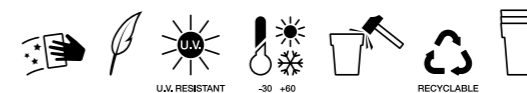

032

antracite/anthracite
anthracite/anthrazitgrau

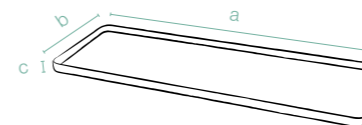

codice senza colore code without colour	Cm	dimensioni dimensions	Confezione minima Minimum package
29 481 098	043 201 039 235	98	a93,5 b33 c3h 2

Sottovaso Pixel

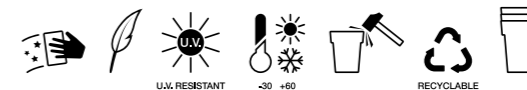

201

cappuccino/cappuccino
cappuccino/cappuccino

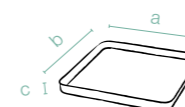

codice senza colore code without colour	Cm	dimensioni dimensions	Confezione minima Minimum package
29 482 038	043 032 039 235	38	a33,5 b33,5 c3h 2

Groove family
componibile
modular
modulable
zusammensetzbar



Indy e Pixel si prestano molto bene per organizzare gli spazi

Indy and Pixel lend very well to organize spaces

Indy et Pixel se prêtent très bien pour l'organisation des espaces

Indy und Pixel sind ideal für die Organization der Räume

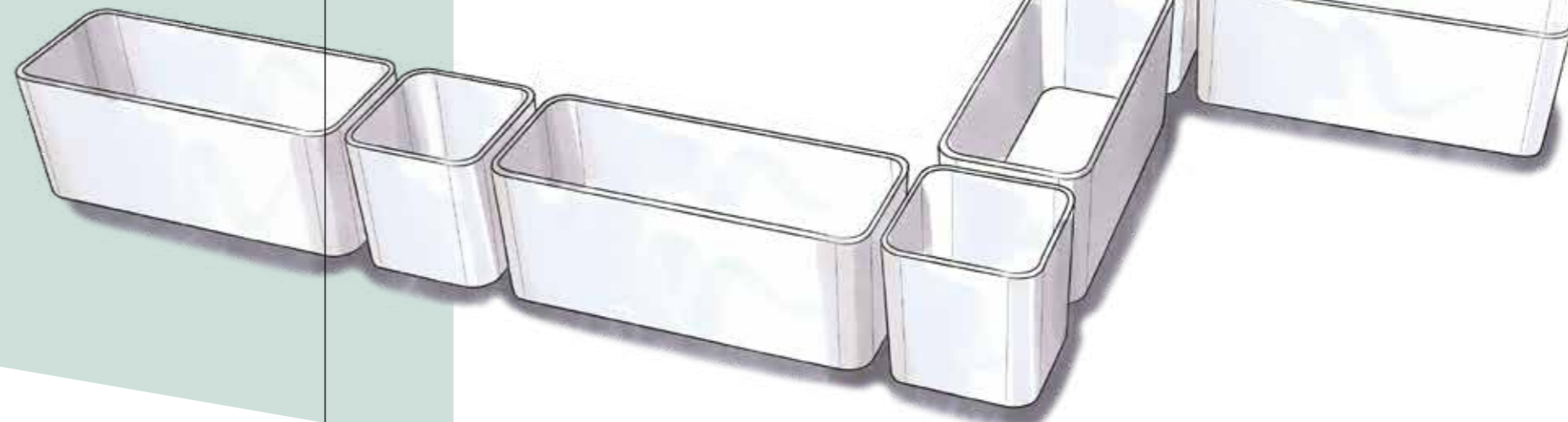



043
bianco/white
blanc/weiß



201
cappuccino/cappuccino
cappuccino/cappuccino



235
beton/beton
beton/beton



032
antracite/anthracite
anthracite/anthrazitgrau



039
bronzo/bronze
bronze/bronze

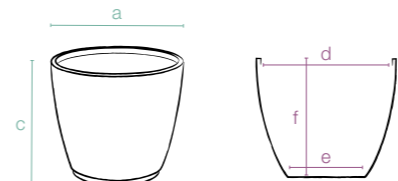

Ring

codice senza colore code without colour	Cm	dimensioni esterne external dimensions			dimensioni interne internal dimensions			litri liters	Confezione minima Minimum package	m ³	pezzi pallet pcs pallet	m ³
29 475 038	38	a38	b38	c32	d36	e24,5	f31,5	25	2 38x38x51h	0,074	42 80x120x115h	1,104
29 475 048	48	a48	b48	c40,5	d45,6	e31	f40	54	2 48x48x62h	0,143	45 80x120x230h	2,208
29 475 057	57	a57	b57	c48	d55,5	e37,5	f47,5	92	2 58x58x74h	0,249	24 80x120x230h	2,208



043
bianco/white
blanc/weiß



201
cappuccino/cappuccino
cappuccino/cappuccino



235
beton/beton
beton/beton



032
antracite/anthracite
anthracite/anthrazitgrau



039
bronzo/bronze
bronze/bronze

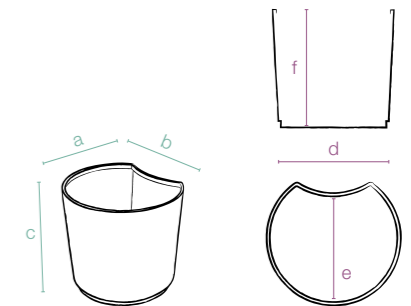

codice senza colore code without colour	Cm	dimensioni esterne external dimensions			dimensioni interne internal dimensions			litri liters	Confezione minima Minimum package	m ³	pezzi pallet pcs pallet	m ³
29 472 040	40	a41	b46,6	c39,8	d44,5	e35	f38,5	52	2 41x46,6x63h	0,11	44	80x120x230h 2,2
29 472 047	47	a46,3	b51,5	e47,2	d49	e41	f46	77	2 46,3x51,5x67h	0,16	40	100x115x224h 2,5
29 472 054	54	a51,4	b56,1	e54	d54	e45	f53	106	2 51,4x56,1x72,5h	0,2	36	100x115x218h 2,5

Urban SET 3 P.

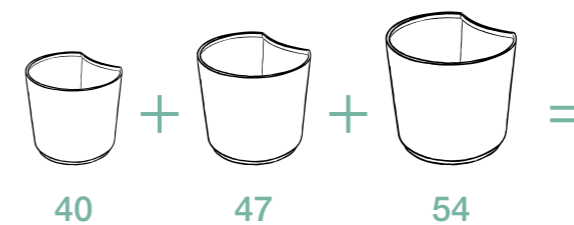

codice senza colore code without colour	Cm	dimensioni dimensions			Confezione minima Minimum package	m ³	pezzi pallet pcs pallet	m ³
14 999 002	40	a51,4	b56,1	e54	1 51,4x56,1x54h	0,15	16	100x120x204h 2,4



Urban

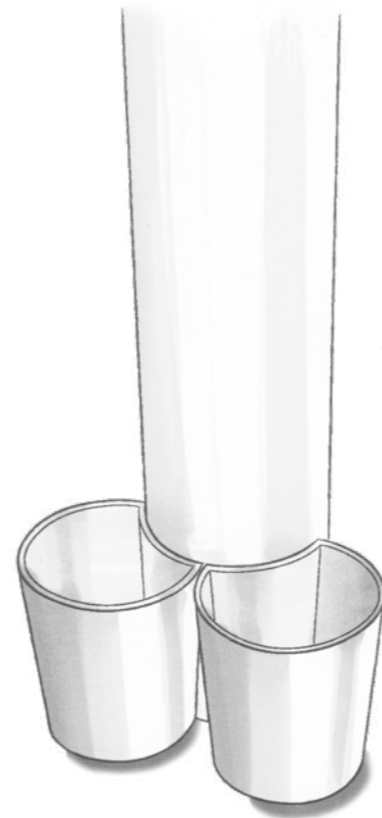

Urban family
componibile
modular
modulable
zusammensetzbar



Grazie ai diversi formati disponibili, Urban permette di creare tantissime composizioni e di modificarle con grande facilità.

With the different sizes of Urban you can create many compositions and modify them easily.

Les différentes mesures de l' Urban vous permettent de créer de nombreuses compositions et de les modifier facilement.

Mit den verschiedenen Größen des Urbans sind viele Zusammensetzungen möglich, die sich auch leicht ändern lassen.





linea
ESSENTIAL



Divio



Corner



Schio Cassa



Schio Sottocubo



Schio Cubo Basso



Schio Cubo Alto



Schio Cassa Alta



Schio Cono



Zamora



Leon



Standard One



Quadro Veneto



Cassa Veneto



Schio Sottocassa



Schio Cassa Maxi

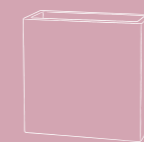

Schio Tower Maxi



Schio Tower



Schio Cubo



Schio Ciotola



Valentino



Bassano



Avila



Ribeira



Jardinera Veneto



Tondo Veneto



Pasubio Alto



Pasubio Quadro



Pasubio Cassa



Divio indoor



043
bianco/white
blanc/weiß



201
cappuccino/cappuccino
cappuccino/cappuccino



210
grafite/graphite
graphite/graphit



232
kiwi/kiwi
kiwi/Kiwi

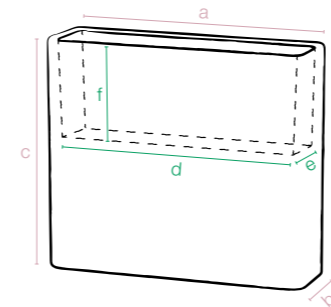

codice senza colore code without colour	Cm	dimensioni esterne external dimensions	dimensioni interne internal dimensions	litri liters	Confezione minima Minimum package	m ³	pezzi pallet pcs pallet	m ³
11 466 080	80	a:90 b:27 c:77	d:85 e:21 f:33	59	1 91x28x79h	0,2	8 80x120x230h	1,93

Corner indoor



043
bianco/white
blanc/weiß



201
cappuccino/cappuccino
cappuccino/cappuccino



210
grafite/graphite
graphite/graphit



232
kiwi/kiwi
kiwi/Kiwi

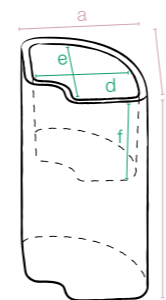

codice senza colore code without colour	Cm	dimensioni esterne external dimensions	dimensioni interne internal dimensions	litri liters	Confezione minima Minimum package	m ³	pezzi pallet pcs pallet	m ³
11 467 080	80	a:39 b:39 c:77	d:22 e:34 f:33	26	1 40x40x79h	0,1	15 80x120x230h	1,93



Superficie opaca
Matt finished
Surface opaque
Matt-Oberfläche



Divio e Corner

Divio + Corner
componibili
modular
modulable
zusammensetzbar

permettono diverse combinazioni
 allow various combinations
 ils permettent différentes combinaisons
 Divio und Corner ermöglichen viele Zusammenstellungen

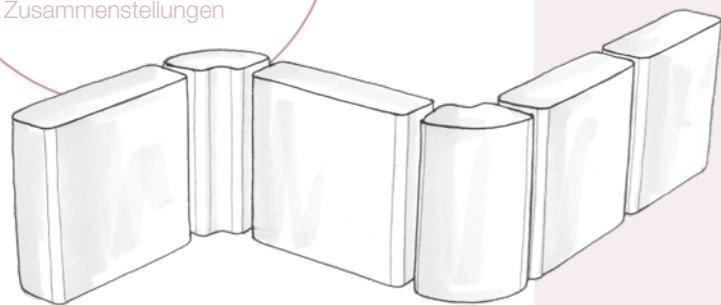

in base all'ambiente
 depending on the environment
 en fonction de l'environnement
 nach dem Raum

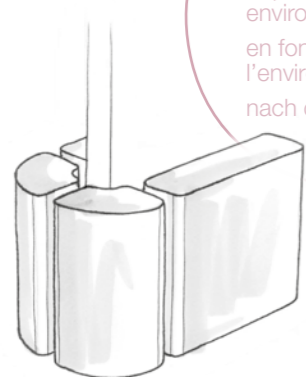

Divio e Corner si prestano molto bene per organizzare gli spazi

DIVIO and CORNER lend very well to organize spaces

Divio et Corner se prêtent très bien pour l'organisation des espaces

Divio und Corner sind ideal für die Teilung der Räume

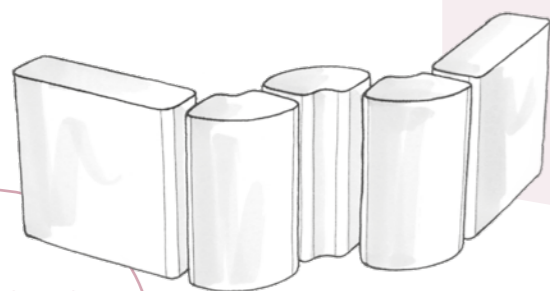

e alla vostra fantasia
 and to your imagination
 et à votre imagination
 und Ihrer Fantasie

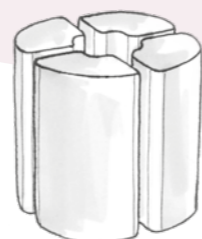

Divio

Corner

indoor

outdoor

sabbia
 sand
 sable
 Sand

Tappo per inserimento sabbia
 Stopper to insert the sand
 Bouchon pour l'insertion du sable
 Verschluss für das Einfügen des Sandes

foro di drenaggio per l'acqua in eccesso
 drainage bore for water's excess
 trou de drainage pour l'eau en excès
 Entwässerungsloch

Divio outdoor

codice senza colore code without colour	Cm	dimensioni esterne external dimensions	dimensioni interne internal dimensions	litri liters	Confezione minima Minimum package	m ³	pezzi pallet pcs pallet	m ³
15 466 080	043 201 210 232 80	a90 b27 c77	d85 e21 f33	59	1 91x28x79h	0,2	8 80x120x230h	1,93

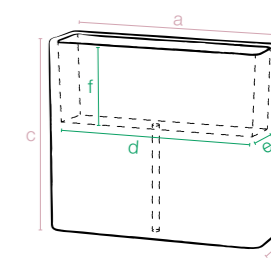

Corner outdoor

codice senza colore code without colour	Cm	dimensioni esterne external dimensions	dimensioni interne internal dimensions	litri liters	Confezione minima Minimum package	m ³	pezzi pallet pcs pallet	m ³
15 467 080	043 201 210 232 80	a39 b39 c77	d22 e34 f33	26	1 40x40x79h	0,1	15 80x120x230h	1,93

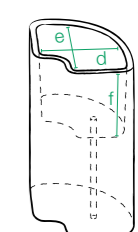

Essential Self Watering



Riserva d'acqua

La riserva d'acqua permette di alimentare le vostre piante senza bisogno di irrigarle spesso. I fori di drenaggio per il "troppo pieno" permettono di scaricare eventuali eccessi di acqua così sarà la pianta stessa ad attingere alla riserva d'acqua quando ne avrà bisogno.

Self-watering system

The Self-watering system allows to feed your plants without having to water it often. The drainage holes for the "overflow" allow you to download any excess water so the plant itself will be to draw on the reserve of water when it needs them. Some of the pots equipped with this system also have a coating membrane that, once removed, it allows excess water to leak from the pots.

Avec reserve de l'eau

Le réservoir d'eau permet de nourrir vos plantes sans avoir à les arroser souvent. Les trous de drainage pour le «débordement» vous permettent de télécharger tout excès d'eau de sorte que sera elle-même à puiser dans la réserve d'eau quand il en aura besoin. Certains des pots équipés de ce système ont également une membrane d'enrobage qui, une fois enlevé, permet à l'eau en excès de sortir.

Wasser reservoir

Das Wasser-Reservoir ermöglicht, Ihre Pflanzen zu versorgen, ohne ständig Wasser zuzuführen. Die Entwässerungslöcher lassen das Wasser überlaufen, damit die Pflanze das nach Bedarf schöpfen kann. Einige Pflanzgefäße mit Wasserspeicher besitzen eine Abdeckung-Membrane, die das Wasser, bei Wegnahme, überlaufen lässt.

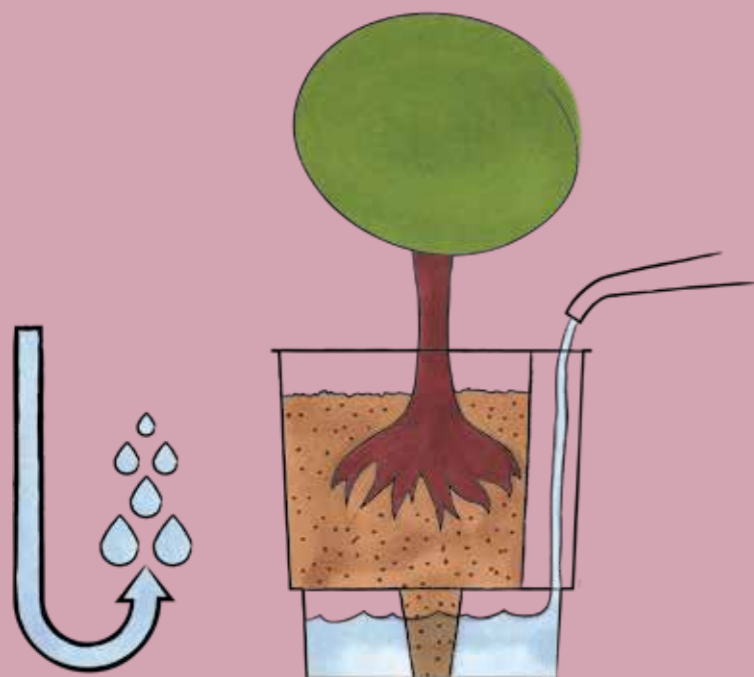

Evita l'annidamento di zanzare e altri insetti

It stops mosquitoes and other insects from laying eggs

Évite la nidation des moustiques et autres insectes

Das Einnisten von Mücken und anderen Insekten wird verhindert

Divio self watering



043
bianco/white
blanc/weiß



201
cappuccino/cappuccino
cappuccino/cappuccino



210
grafite/graphite
graphite/graphit



232
kiwi/kiwi
kiwi/Kiwi

codice senza colore code without colour	Cm	dimensioni esterne external dimensions	Confezione minima Minimum package	m ³	pezzi pallet pcs pallet	m ³
16 466 080	80	a90 b27 c77	1 91x28x79h	0,2	8 80x120x230h	1,93

diffusione dell'acqua per osmosi
water diffusion through osmosis's effect
diffusion de l'eau par osmose
Wasserdiffusion durch Osmose

riserva d'acqua
Self-watering system
réserve d'eau
Wasser-Reservoir

beccuccio per inserimento dell'acqua
spout for water insertion
bec pour l'introduction de l'eau
Füllschacht zur Wasserversorgung

griglia di drenaggio
drainage grid
gril pour le drainage
Bewässerungseinsatz

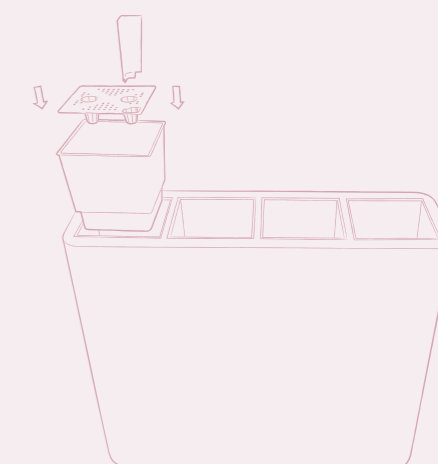
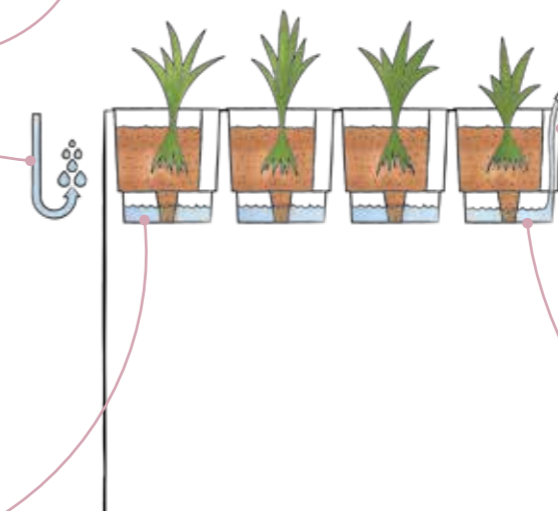



Schio cassa



Superficie opaca
Matt finished
Surface opaque
Matt-Oberfläche



043
bianco/white
blanc/weiß



201
cappuccino/cappuccino
cappuccino/cappuccino



032
antracite/anthracite
anthracite/anthrazitgrau



235
beton/beton
beton/beton



050
rosso cardinale/cardinal red
rouge cardinal/scharlachrot



039
bronzo/bronze
bronze/bronze

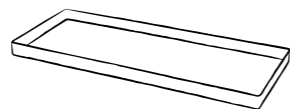
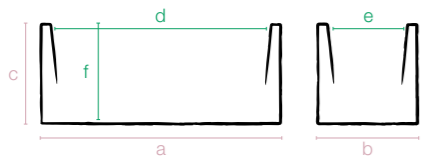

Sottocassa
pagina 221

codice senza colore code without colour	Cm	dimensioni esterne external dimensions			dimensioni interne internal dimensions			litri liters	Confezione minima Minimum package	m ³	pezzi pallet pcs pallet	m ³		
11 427 060	60	a 60	b 25	c 25	d 54	e 20	f 25	26	2	60x25x50h	0,07	24	80x120x115h	1,10
11 427 080	80	a 80	b 30	c 30	d 73	e 24	f 30	51	2	80x30x30h	0,07	28	80x120x222h	2,13
11 427 100	100	a 100	b 40	c 40	d 90	e 30	f 40	108	1	100x40x40h	0,16	10	80x120x210h	2,52
11 427 120	120	a 115	b 50	c 50	d 103	e 38	f 50	195	1	115x50x50h	0,28	8	115x100x215h	2,47

Schio sottocassa

Schio cassa
+
Schio sottocassa



043
bianco/white
blanc/weiß



201
cappuccino/cappuccino
cappuccino/cappuccino



032
antracite/anthracite
anthracite/anthrazitgrau



235
beton/beton
beton/beton



050
rosso cardinale/cardinal red
rouge cardinal/scharlachrot



039
bronzo/bronze
bronze/bronze

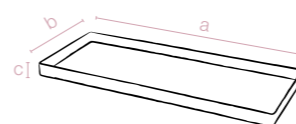

codice senza colore code without colour	Cm	dimensioni esterne external dimensions			Confezione minima Minimum package	m ³	pezzi pallet pcs pallet	m ³
11 479 080	80	a 80	b 30	c 4	2	vedi Schio cassa p.200	see Schio cassa p. 200	
11 479 100	100	a 101	b 41	c 5,5	2	vedi Schio cassa p.200	see Schio cassa p. 200	



Schio Cassa maxi

Superficie opaca / Matt finished
Surface opaque / Matt-Oberfläche

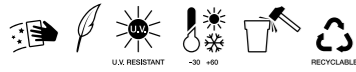

043
bianco/white
blanc/weiß



201
cappuccino/cappuccino
cappuccino/cappuccino



032
antracite/anthracite
anthracite/anthrazitgrau



235
beton/beton
beton/beton



050
rosso cardinale/cardinal red
rouge cardinal/scharlachrot



039
bronzo/bronze
bronze/bronze

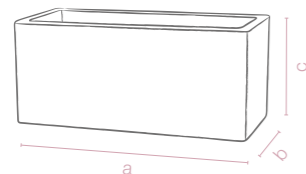

new
SIZE

79x39x40

codice senza colore code without colour	Cm	dimensioni esterne external dimensions	dimensioni interne internal dimensions	litri liters	Confezione minima Minimum package	m ³	pallet pcs pallet	m ³
11484080	80	a79 b39 c40	d69 e29 f40	80	1 79x39x40h	0,12	6 80x120x95h	0,9

Schio Tower maxi

Superficie opaca / Matt finished
Surface opaque / Matt-Oberfläche



043
bianco/white
blanc/weiß



201
cappuccino/cappuccino
cappuccino/cappuccino



032
antracite/anthracite
anthracite/anthrazitgrau



235
beton/beton
beton/beton



050
rosso cardinale/cardinal red
rouge cardinal/scharlachrot



039
bronzo/bronze
bronze/bronze

new
SIZE

79x39x90

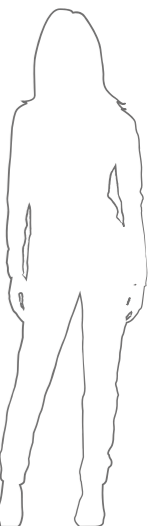
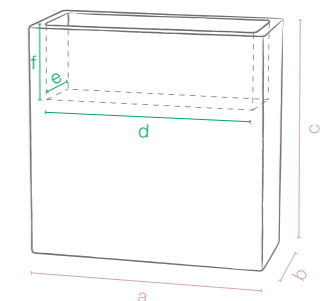

codice senza colore code without colour	Cm	dimensioni esterne external dimensions	dimensioni interne internal dimensions	litri liters	Confezione minima Minimum package	m ³	pallet pcs pallet	m ³
11485080	80	a79 b39 c90	d64 e29 f28	52	1 79x39x90h	0,28	6 80x120x195h	1,87

Schio Tower

Superficie opaca / Matt finished
Surface opaque / Matt-Oberfläche

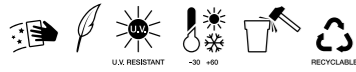

043
bianco/white
blanc/weiß



201
cappuccino/cappuccino
cappuccino/cappuccino



032
antracite/anthracite
anthracite/anthrazitgrau



235
beton/beton
beton/beton



050
rosso cardinale/cardinal red
rouge cardinal/scharlachrot



039
bronzo/bronze
bronze/bronze

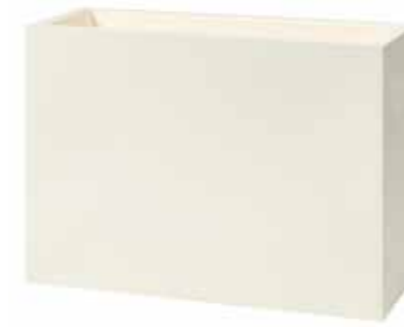

043
bianco/white
blanc/weiß



201
cappuccino/cappuccino
cappuccino/cappuccino



032
antracite/anthracite
anthracite/anthrazitgrau



235
beton/beton
beton/beton



050
rosso cardinale/cardinal red
rouge cardinal/scharlachrot



039
bronzo/bronze
bronze/bronze

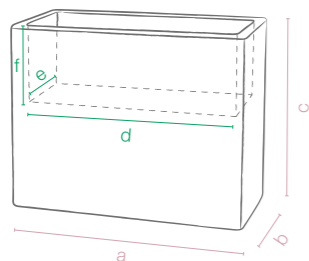

codice senza colore code without colour	Cm	dimensioni esterne external dimensions	dimensioni interne internal dimensions	litri liters	Confezione minima Minimum package	m ³	pallet pcs pallet	m ³
11486080	80	a79 b39 c70	d64 e29 f28	52	1 79x39x70h	0,22	9 80x120x225h	2,16

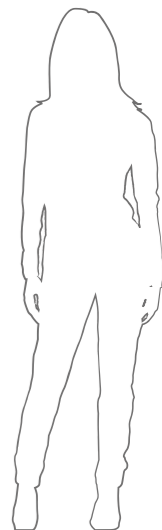
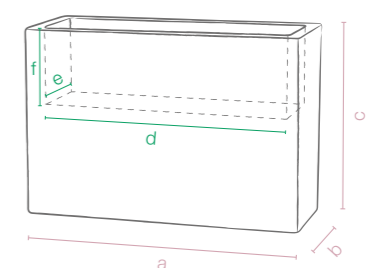

codice senza colore code without colour	Cm	dimensioni esterne external dimensions	dimensioni interne internal dimensions	litri liters	Confezione minima Minimum package	m ³	pallet pcs pallet	m ³
11486100	100	a99 b39 c70	d84 e29 f28	68	1 99x39x70h	0,27	6 80x120x225h	2,16





Schio family
componibile
 modular
 modulaire
 zusammensetzbar

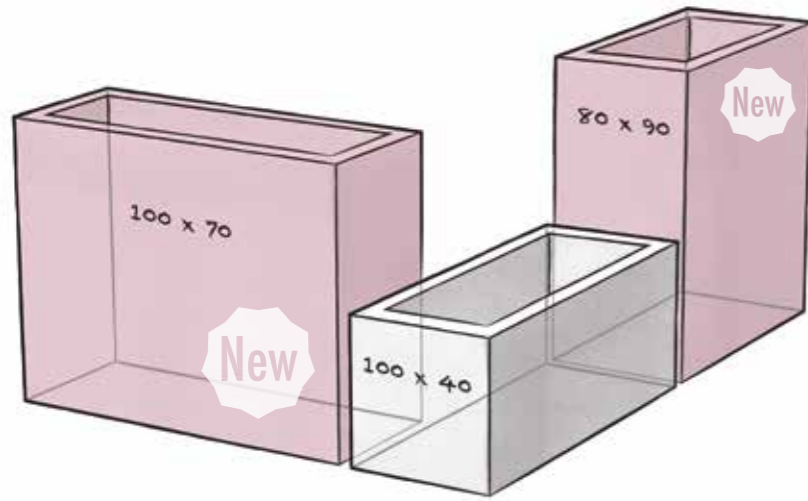

Schio cubo, Schio cubo alto, Schio cassa, Schio Cassa maxi, Schio Tower maxi e Schio Tower si prestano molto bene per organizzare gli spazi

Schio cubo, Schio cubo alto, Schio cassa, Schio Cassa maxi, Schio Tower maxi and Schio Tower lend very well to organize spaces

Schio cubo, Schio cubo alto, Schio cassa, Schio Cassa maxi, Schio Tower maxi et Schio Tower se prêtent très bien pour l'organisation des espaces

Schio cubo, Schio cubo alto, Schio cassa, Schio Cassa maxi, Schio Tower maxi und Schio Tower sind ideal für die Organization der Räume

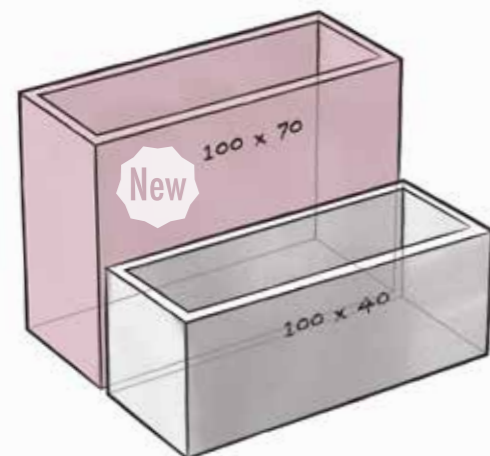
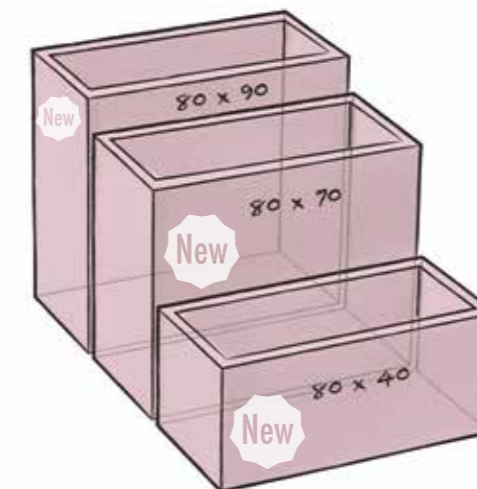
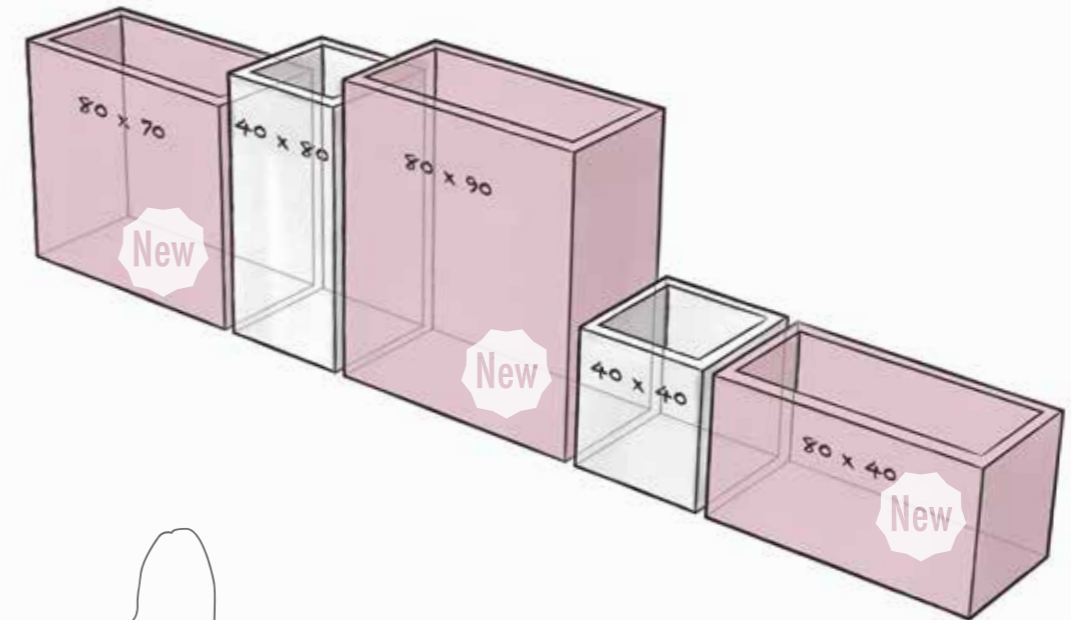
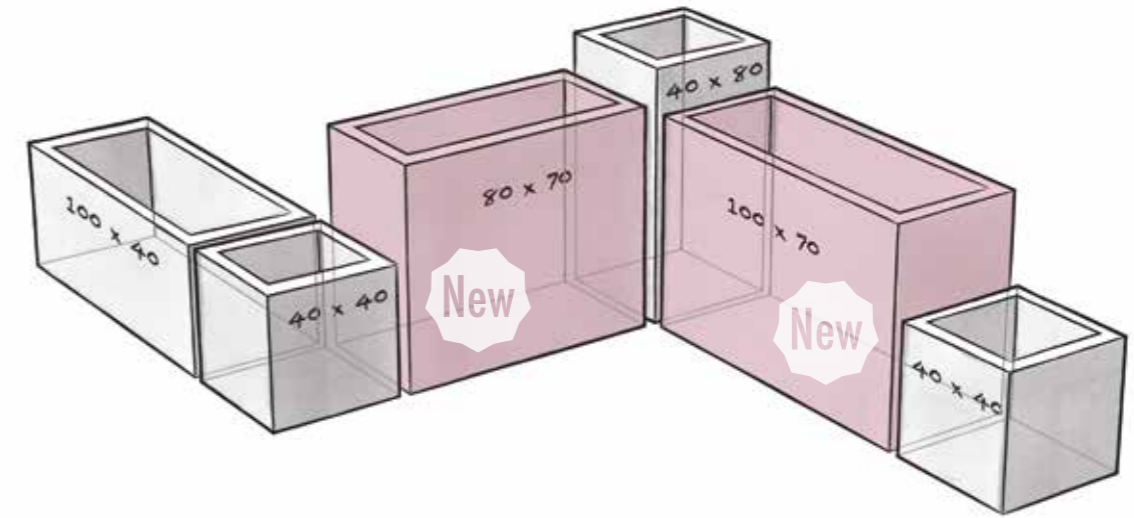
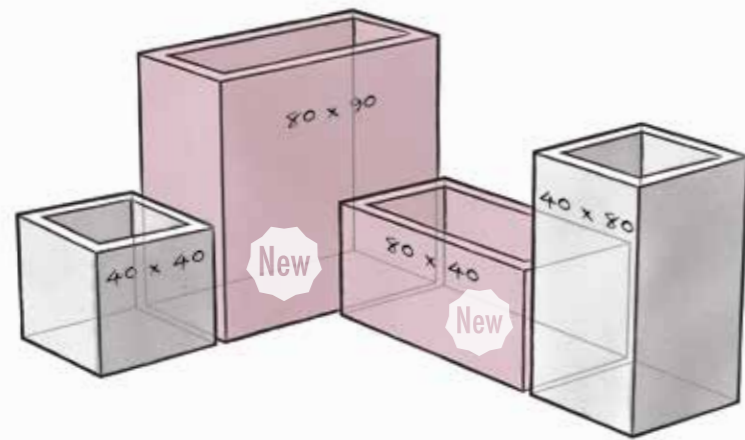

Schio cassa self watering



043

bianco/white
blanc/weiß



201

cappuccino/cappuccino
cappuccino/cappuccino



032

antracite/anthracite
anthracite/anthrazitgrau



235

beton/beton
beton/beton



050

rosso cardinale/cardinal red
rouge cardinal/scharlachrot



039

bronzo/bronze
bronze/bronze

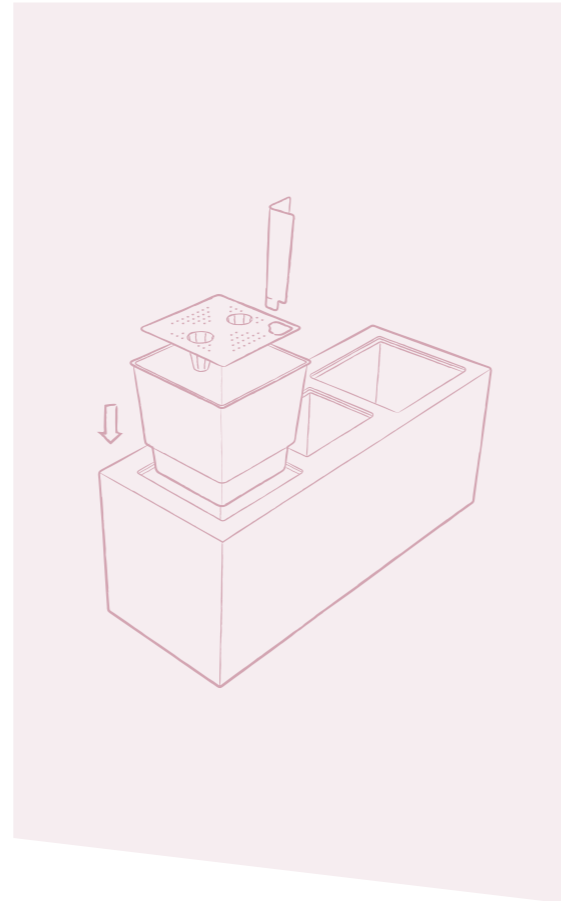

Schio cubo



Superficie opaca
Matt finished
Surface opaque
Matt-Oberfläche

codice senza colore code without colour	Cm	dimensioni esterne external dimensions	Confezione minima Minimum package	m ³	pezzi pallet pcs pallet	m ³
16 427 080	80	a80 b30 c30	2 80x30x30h	0,07	28 80x120x222h	2,13



diffusione dell'acqua
per osmosi
water diffusion through
osmosis's effect
diffusion de l'eau par
osmose
Wasserdiffusion durch
Osmose

griglia di drenaggio
drainage grid
gril pour le drainage
Bewässerungseinsatz

riserva d'acqua
Self-watering system
réserve d'eau
Wasser-Reservoir

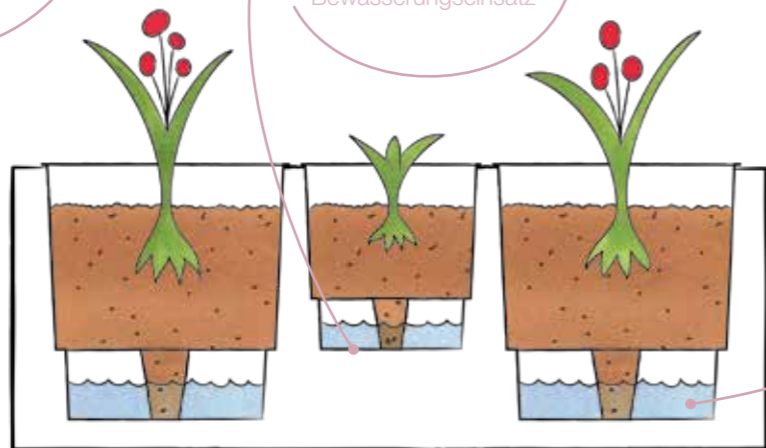

043

bianco/white
blanc/weiß



201

cappuccino/cappuccino
cappuccino/cappuccino



032

antracite/anthracite
anthracite/anthrazitgrau



235

beton/beton
beton/beton



050

rosso cardinale/cardinal red
rouge cardinal/scharlachrot



039

bronzo/bronze
bronze/bronze

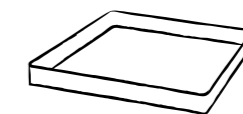

Sottocubo
pagina 234

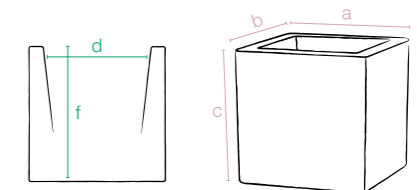

codice senza colore code without colour	Cm	dimensioni esterne external dimensions	dimensioni interne internal dimensions	litri liters	Confezione minima Minimum package	m ³	pezzi pallet pcs pallet	m ³
11 425 025	25	a25 b25 c25	d19,5 e19,5 f24	9	1 25x25x25h	0,01	48 80x120x115h	0,55
11 425 030	30	a30 b30 c30	d23,5 e23,5 f28	15	1 30x30x30h	0,02	24 80x120x115h	1,10
11 425 040	40	a40 b40 c40	d30 e30 f38	34	1 40x40x40h	0,06	12 80x120x92h	0,88
11 425 050	50	a50 b50 c50	d38 e38 f48	55	1 50x50x50h	0,12	8 100x120x112h	1,34
11 425 060	60	a58 b58 c58	d45 e45 f58	117	1 58x58x58h	0,19	6 80x120x200h	1,92



Schio sottocubo

Schio cubo
+
Schio sottocubo



043
bianco/white
blanc/weiß



201
cappuccino/cappuccino
cappuccino/cappuccino



032
antracite/anthracite
anthracite/anthrazitgrau



235
beton/beton
beton/beton



039
bronzo/bronze
bronze/bronze



050
rosso cardinale/cardinal red
rouge cardinal/scharlachrot

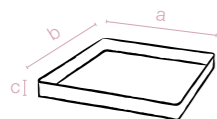

codice senza colore code without colour	Cm	dimensioni esterne external dimensions	Confezione minima Minimum package	m ³	pezzi pallet pcs pallet	m ³
11 480 040	40	a40 b40 c5,5	2	vedi Schio cubo pag. 202	see Schio cubo p. 202	

Schio cubo self watering



043
bianco/white
blanc/weiß



201
cappuccino/cappuccino
cappuccino/cappuccino



032
antracite/anthracite
anthracite/anthrazitgrau



235
beton/beton
beton/beton



050
rosso cardinale/cardinal red
rouge cardinal/scharlachrot



039
bronzo/bronze
bronze/bronze

codice senza colore code without colour	Cm	dimensioni esterne external dimensions	Confezione minima Minimum package	m ³	pezzi pallet pcs pallet	m ³
16 425 030	30	a30 b30 c30	1	30x30x30h	0,02	24 80x120x115h 1,10

diffusione dell'acqua
per osmosi
water diffusion through
osmosis's effect
diffusion de l'eau par
osmose
Wasserdiffusion durch
Osmose

riserva d'acqua
Self-watering system
réserve d'eau
Wasser-Reservoir

griglia di drenaggio
drainage grid
gril pour le drainage
Bewässerungseinsatz

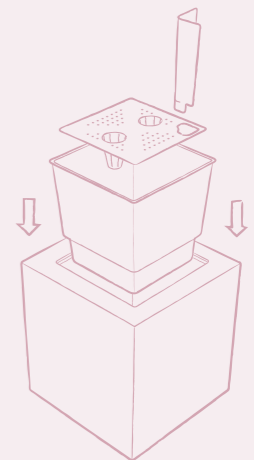
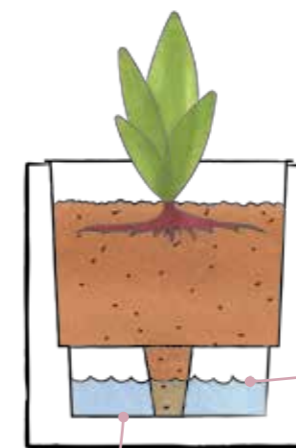

Schio

cubo basso



Superficie opaca
Matt finished
Surface opaque
Matt-Oberfläche



Schio

cubo alto



Superficie opaca
Matt finished
Surface opaque
Matt-Oberfläche



043
bianco/white
blanc/weiß



201
cappuccino/cappuccino
cappuccino/cappuccino



032
antracite/anthracite
anthracite/anthrazitgrau



235
beton/beton
beton/beton



050
rosso cardinale/cardinal red
rouge cardinal/scharlachrot



039
bronzo/bronze
bronze/bronze



043
bianco/white
blanc/weiß



201
cappuccino/cappuccino
cappuccino/cappuccino



032
antracite/anthracite
anthracite/anthrazitgrau



235
beton/beton
beton/beton



050
rosso cardinale/cardinal red
rouge cardinal/scharlachrot



039
bronzo/bronze
bronze/bronze

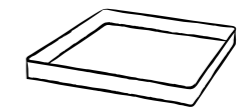

Sottocubo
pagina 234

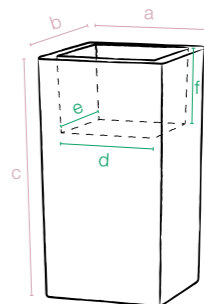

**Fix Ground
Fix Wall**
pagina 300

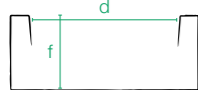
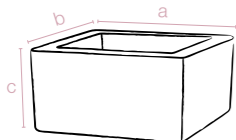

codice senza colore code without colour	Cm	dimensioni esterne external dimensions	dimensioni interne internal dimensions	litri liters	Confezione minima Minimum package	m ³	pezzi pallet pcs pallet	m ³
11 456 050	50	a50 b50 c20	d40 e40 f19	26	1 50x50x20h	0,05	14 80x60x115h	0,55

codice senza colore code without colour	Cm	dimensioni esterne external dimensions	dimensioni interne internal dimensions	litri liters	Confezione minima Minimum package	m ³	pezzi pallet pcs pallet	m ³	accessori accessories
11 426 080	80	a40 b40 c80	d30 e30 f20	31	1 40x40x80h	0,07	15 80x120x213h	2,05	



Schio

cassa alta



Superficie opaca
Matt finished
Surface opaque
Matt-Oberfläche



Schio

cono



Superficie opaca
Matt finished
Surface opaque
Matt-Oberfläche



043
bianco/white
blanc/weiß



201
cappuccino/cappuccino
cappuccino/cappuccino



032
antracite/antracite
anthracite/anthrazitgrau



235
beton/beton
beton/beton



050
rosso cardinale/cardinal red
rouge cardinal/scharlachrot



039
bronzo/bronze
bronze/bronze

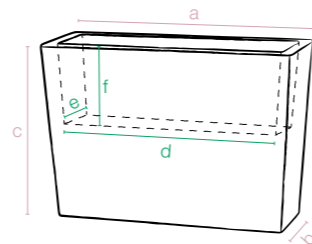

043
bianco/white
blanc/weiß



201
cappuccino/cappuccino
cappuccino/cappuccino



032
antracite/antracite
anthracite/anthrazitgrau



235
beton/beton
beton/beton



050
rosso cardinale/cardinal red
rouge cardinal/scharlachrot



039
bronzo/bronze
bronze/bronze

Fix Ground
Fix Wall
pagina 300

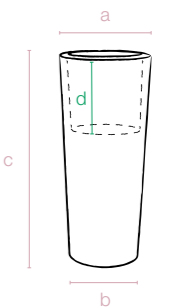

codice senza colore code without colour	Cm	dimensioni esterne external dimensions	dimensioni interne internal dimensions	litri liters	Confezione minima Minimum package	m³	pezzi pallet pcs pallet	m³
11 428 050	50	a50 b36 c70	d40 e26 f30	31	1 50x40x70h	0,14	12 80x120x222h	2,13
11 428 100	100	a100 b36 c70	d90 e26 f30	70	1 100x40x70h	0,28	6 80x120x222h	2,13

codice senza colore code without colour	Cm	dimensioni dimensions	litri liters	Confezione minima Minimum package	m³	pezzi pallet pcs pallet	m³	accessori accessoires
11 424 070	70	a30 b23 c68 d20	8	1 30x30x68h	0,06	24 80x120x225h	2,16	[Icon]
11 424 090	90	a40 b29,5 c90 d26	26	1 40x40x90h	0,14	12 80x120x195h	1,87	[Icon]
11 424 110	110	a45 b34,5 c110 d28	35	1 45x45x110h	0,22	12 80x120x236h	2,27	[Icon]
11 424 145	145	a55 b44,5 c145 d31	46	1 55x55x145h	0,43	4 100x120x160h	1,92	[Icon]



Schio family
componibile
modular
modulable
zusammensetzbar

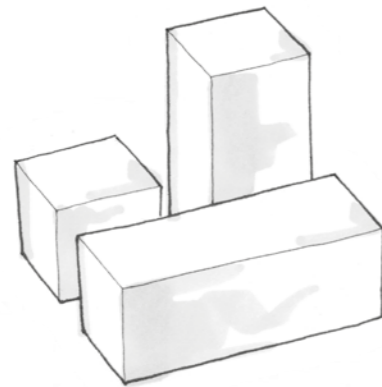
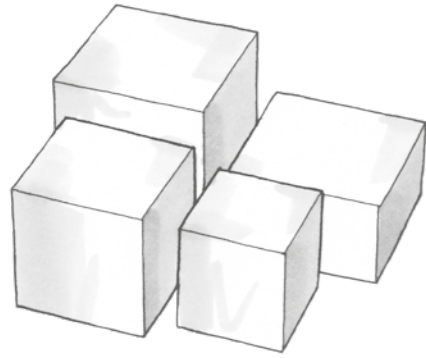

“Semplicemente accostando 3 vasi
ho dato un ordine al mio giardino”

“By simply approaching 3 pots I gave
an order to my garden.”

“En approchant simplement 3 pots
j’ai donné un ordre à mon jardin”

“Ich habe 3 Töpfe zusammengestellt
und mein Garten sieht gepflegter aus”

Alessandra

Schio cubo, Schio cubo alto e
Schio cassa si prestano molto
bene per organizzare gli spazi

Schio cubo, Schio cubo alto
and Schio cassa lend very
well to organize spaces

Schio Cubo, Cubo Alto et
Cassa se prêtent très bien
pour l’organisation des
espaces

Schio Cubo, Schio Cubo Alto
und Schio Cassa sind ideal für
die Organization der Räume

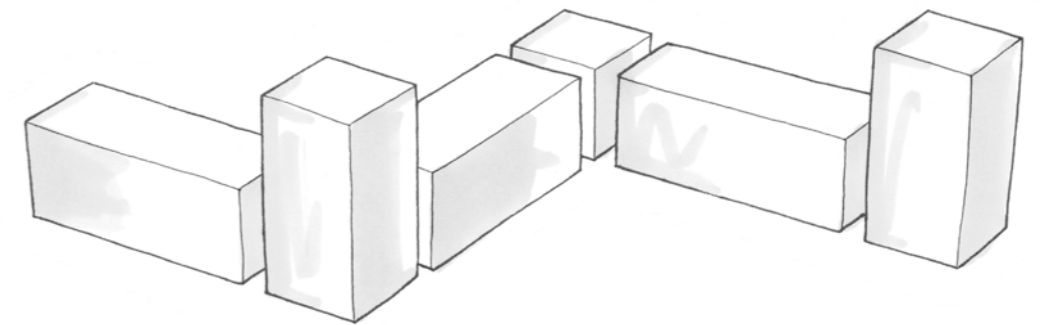
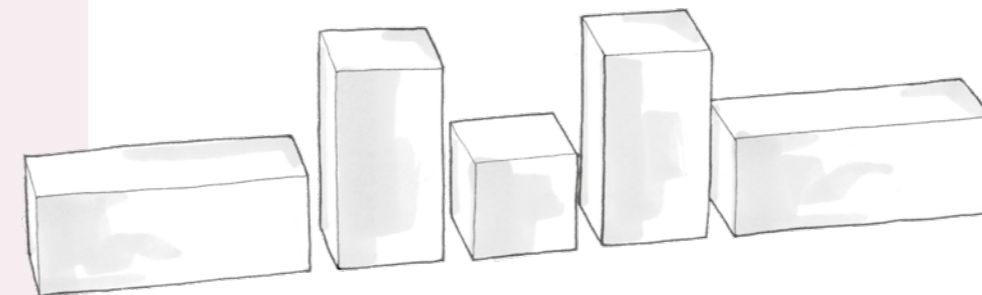
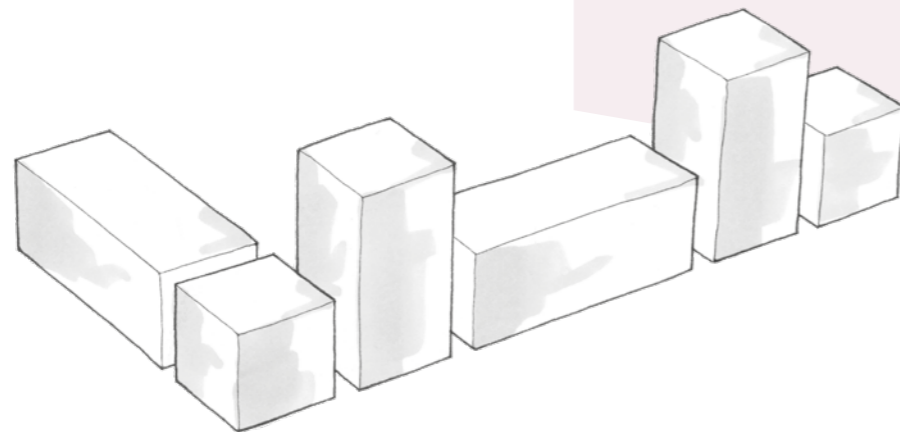

Schio ciotola



Superficie opaca
Matt finished
Surface opaque
Matt-Oberfläche



Valentino

Superficie opaca / Matt finished
Surface opaque / Matt-Oberfläche



043
bianco/white
blanc/weiß



201
cappuccino/cappuccino
cappuccino/cappuccino



032
antracite/anthracite
anthracite/anthrazitgrau



050
rosso cardinale/cardinal red
rouge cardinal/scharlachrot

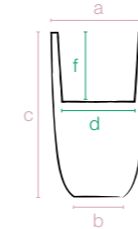

codice senza colore code without colour	Cm	dimensioni esterne external dimensions			dimensioni interne internal dimensions		litri liters	Confezione minima Minimum package	m ³	pezzi pallet pcs pallet	m ³	accessori accessories	
11 432 050	50	a34	b21	c50	d26	f22	10	2 34x68x50h	0,11	16	80x120x112h	1,08	
11 432 070	70	a42	b25	c70	d32	f28	17	1 42x42x70h	0,12	18	80x120x226h	2,17	
11 432 090	90	a52	b30	c90	d40	f28	29	1 52x52x90h	0,24	8	100x120x195h	2,34	

Fix Ground - Fix Wall
pagina 300

Bassano

Superficie opaca / Matt finished
Surface opaque / Matt-Oberfläche



043
bianco/white
blanc/weiß



201
cappuccino/cappuccino
cappuccino/cappuccino



032
antracite/anthracite
anthracite/anthrazitgrau



050
rosso cardinale/cardinal red
rouge cardinal/scharlachrot

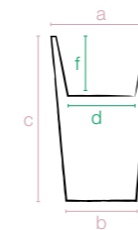

codice senza colore code without colour	Cm	dimensioni esterne external dimensions			dimensioni interne internal dimensions		litri liters	Confezione minima Minimum package	m ³	pezzi pallet pcs pallet	m ³	accessori accessories	
11 423 060	60	a45	b29	c60	d27	f20	10	1 45x45x60h	0,12	24	80x120x202h	1,94	
11 423 100	100	a60	b35	c100	d35	f34	20	1 60x60x100h	0,36	6	100x120x165h	1,58	

Fix Ground - Fix Wall
pagina 300



043
bianco/white
blanc/weiß



201
cappuccino/cappuccino
cappuccino/cappuccino



032
antracite/anthracite
anthracite/anthrazitgrau



235
beton/beton
beton/beton



050
rosso cardinale/cardinal red
rouge cardinal/scharlachrot



039
bronzo/bronze
bronze/bronze

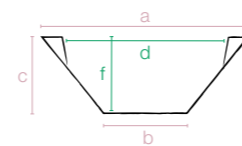

codice senza colore code without colour	Cm	dimensioni esterne external dimensions			dimensioni interne internal dimensions		litri liters	Confezione minima Minimum package	m ³	pezzi pallet pcs pallet	m ³	
11 433 060	60	a60	b24,5	c22	d48	e21	22	2 60x60x30h	0,10	26	80x120x113h	1,08
11 433 080	80	a80	b32,5	c29	d64,5	e28	54	2 80x80x39h	0,25	10	80x80x113h	0,72
11 433 100	100	a100	b40	c37	d80	e36	106	1 100x100x37h	0,37	7	100x120x113h	1,36



043
bianco/white
blanc/weiß



201
cappuccino/cappuccino
cappuccino/cappuccino



032
antracite/anthracite
anthracite/anthrazitgrau



202
lavanda/lavender
lavande/lavendel



068
fucsia/fuchsia
fuchsia/fuchsiafarbig



232
kiwi/kiwi
kiwi/Kiwi



Superficie opaca
Matt finished
Surface opaque
Matt-Oberfläche



Avila

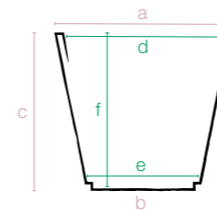

codice senza colore code without colour	Cm	dimensioni esterne external dimensions	dimensioni interne internal dimensions	litri liters	Confezione minima Minimum package	m ³	pezzi pallet pcs pallet	m ³
11 470 035	35	a33 b18 c30	d30 e17 f29	19	1 33x33x29h	0,03	66 80x120x115h	1,10
11 470 040	40	a38 b25 c33	d38 e25 f32	29	1 38x38x33h	0,05	54 80x120x113h	1,08
11 470 050	50	a49 b32 c42	d49 e32 f42	44	1 49x49x42h	0,10	32 80x120x220h	2,10



Superficie opaca
Matt finished
Surface opaque
Matt-Oberfläche



Ribeira



043
bianco/white
blanc/weiß



201
cappuccino/cappuccino
cappuccino/cappuccino



032
antracite/anthracite
anthracite/anthrazitgrau



039
bronzo/bronze
bronze/bronze



202
lavanda/lavender
lavande/lavendel



068
fucsia/fucsia
fuchsia/fuchsiensfarbig



232
kiwi/kiwi
kiwi/Kiwi



Sottovaso
pagina 274

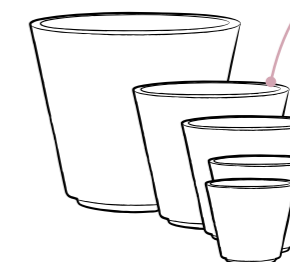

5 misure
5 sizes
5 mesures
5 Größen

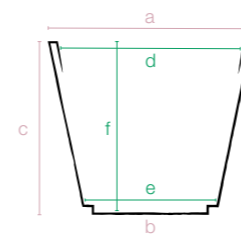

codice senza colore code without colour	Cm	dimensioni esterne external dimensions	dimensioni interne internal dimensions	litri liters	Confezione minima Minimum package	pezzi pallet pcs pallet	m ³
11 461 035	35	a33 b18,5 c28	d30 e18,5 f28	13	2 33x33x37h	63	80x120x115h 1,10
11 461 040	40	a38 b21,5 c33	d34,5 e21,5 f34	21	2 38x38x43h	114	80x120x230h 2,21
11 461 050	50	a49 b27,5 c42	d44,5 e27,5 f42	44	1 49x49x42h	64	100x115x230h 2,65
11 461 060	60	a57 b32 c49	d52 e32 f49	78	1 57x57x49h	28	80x120x220h 2,11
11 461 080	80	a77 b43 c65	d70 e43 f65	191	1 77x77x65h	10	80x80x220h 1,40



043
bianco/white
blanc/weiß



201
cappuccino/cappuccino
cappuccino/cappuccino



068
fucsia/fuchsia
fuchsia/fuchsiensfarbig



232
kiwi/kiwi
kiwi/Kiwi



202
lavanda/lavender
lavande/lavendel



032
antracite/anthracite
anthracite/anthrazitgrau



Sottovaso
pagina 274

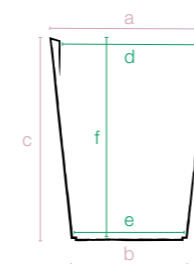

codice senza colore code without colour	Cm	dimensioni esterne external dimensions			dimensioni interne internal dimensions			litri liters		Confezione minima Minimum package	m ³	pezzi pallet pcs pallet	m ³
11 465 043	43	a33	b24	c43	d29	e29	f43	24	27	1 33x33x43h	0,03	96	80x120x225h 2,16
11 465 050	50	a39	b28,5	c50	d35	e28	f49	45	30	1 39x39x50h	0,30	60	80x120x215h 2,06
11 465 065	65	a49	b36	c65	d44	e35	f61	94	47	1 49x49x66h	0,15	21	80x120x210h 2,02



Superficie opaca
Matt finished
Surface opaque
Matt-Oberfläche



Zamora



043
bianco/white
blanc/weiß



201
cappuccino/cappuccino
cappuccino/cappuccino



032
antracite/anthracite
anthracite/anthrazitgrau

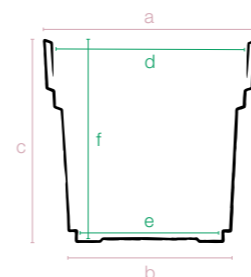

codice senza colore code without colour	Cm	dimensioni esterne external dimensions	dimensioni interne internal dimensions	litri liters	Confezione minima Minimum package	m ³	pezzi pallet pcs pallet	m ³
11 471 035	35	a 33 b 25,5 c 33	d 29 e 23 f 33	9	1 33x33x33h	0,03	63 80x120x115h	1,10
11 471 040	40	a 38 b 30 c 38	d 35 e 26 f 38	15	1 38x38x38h	0,05	48 80x120x118h	1,13



Superficie opaca
Matt finished
Surface opaque
Matt-Oberfläche



Leon



adatto anche per uso esterno
also suitable for outdoor use
également adapté pour une utilisation en extérieur
Outdoor geeignet



043
bianco/white
blanc/weiß



201
cappuccino/cappuccino
cappuccino/cappuccino



030
antico/lavender
marron clair/hellbraun



039
bronzo/bronze
bronze/bronze



050
rosso cardinale/cardinal red
rouge cardinal/scharlachrot



232
kiwi/kiwi
kiwi/Kiwi



202
lavanda/lavender
lavande/lavendel



032
antracite/anthracite
anthracite/anthrazitgrau



Sottovaso
pagina 274

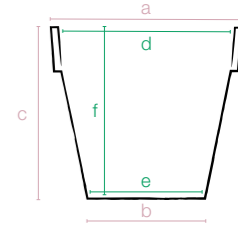

codice senza colore code without colour	Cm	dimensioni esterne external dimensions			dimensioni interne internal dimensions			litri liters	Confezione minima Minimum package	m ³	pezzi pallet pcs pallet	m ³
11 437 030	30	a30	b18,5	c27	d26,5	e18,5	f27	11	22	4 30x30x48h	0,04	88 80x120x115h 1,10
11 437 040	40	a40	b25	c35	d36	e25	f35	26	30	2 40x40x46h	0,07	48 80x120x112h 1,08
11 437 050	50	a50	b31	c43	d44	e31	f43	48	37	2 50x50x58h	0,14	64 100x120x226h 2,71
11 437 060	60	a60	b37	c54	d53	e37	f53	85	47	2 60x60x70h	0,25	22 80x120x215h 2,06
11 437 070	70	a70	b43	c63	d61	e43	f62	133	50	1 70x70x63h	0,30	9 80x80x215h 1,38
11 437 080	80	a80	b49	c72	d70	e49	f71	199	60	1 80x80x72h	0,46	8 80x80x220h 1,41
11 437 100	100	a100	b61	c90	d88	e61	f90	396	66	1 100x100x90h	0,90	6 100x120x225h 2,70
11 437 120	120	a120	b74	c108	d105	e74	f108	686	-	1 120x120x90h	1,29	4 120x120x215h 3,10
11 437 140	140	a140	b86	c128	d123	e86	f126	1079	-	1 140x140x128h	2,51	4 140x140x234h 4,51



Superficie opaca
Matt finished
Surface opaque
Matt-Oberfläche



**Standard
one**

quadro Veneto



Superficie opaca
Matt finished
Surface opaque
Matt-Oberfläche



cassa Veneto



Superficie opaca
Matt finished
Surface opaque
Matt-Oberfläche



043

bianco/white
blanc/weiß



201

cappuccino/cappuccino
cappuccino/cappuccino



039

bronzo/bronze
bronze/bronze



032

antracite/anthracite
anthracite/anthrazitgrau



043

bianco/white
blanc/weiß



201

cappuccino/cappuccino
cappuccino/cappuccino



039

bronzo/bronze
bronze/bronze



032

antracite/anthracite
anthracite/anthrazitgrau

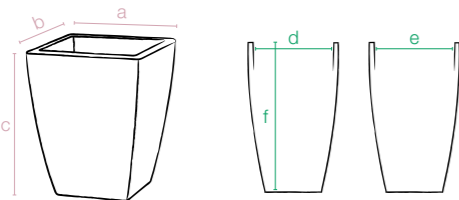

Sottovaso
pagina 275

codice senza colore code without colour	Cm	dimensioni esterne external dimensions			dimensioni interne internal dimensions			litri liters	Confezione minima Minimum package	m ³	pezzi pallet pcs pallet	m ³
11 407 035	35	a29	b29	c36	d25	e25	f36	17	30	2 29x29x57h	0,04	32 80x120x115h 1,10
11 407 040	40	a33	b33	c41	d28,5	e28,5	f41	25	30	2 33x33x66h	0,07	48 80x120x230h 2,21
11 407 050	50	a40	b40	c50	d34	e34	f50	44	36	2 40x40x78h	0,12	42 80x120x228h 2,19
11 407 060	60	a49	b49	c61	d42	e42	f61	83	36	2 49x49x61h	0,14	20 100x115x230h 2,65
11 407 065	65	a40	b40	c65	d34	e34	f65	56	36	2 40x40x107h	0,17	30 80x120x238h 2,28

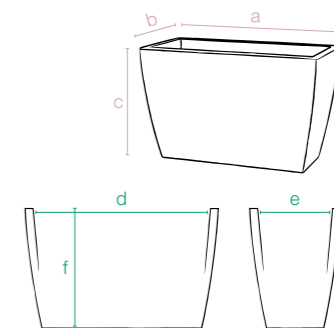

codice senza colore code without colour	Cm	dimensioni esterne external dimensions			dimensioni interne internal dimensions			litri liters	Confezione minima Minimum package	m ³	pezzi pallet pcs pallet	m ³
11 438 080	80	a80	b40	c50	d74	e35	f50	169	2 80x40x80h	0,25	18 80x120x228h 2,19	



jardinera Veneto



Superficie opaca
Matt finished
Surface opaque
Matt-Oberfläche



tondo Veneto



Superficie opaca
Matt finished
Surface opaque
Matt-Oberfläche



043

bianco/white
blanc/weiß



201

cappuccino/cappuccino
cappuccino/cappuccino



032

antracite/anthracite
anthracite/anthrazitgrau



039

bronzo/bronze
bronze/bronze

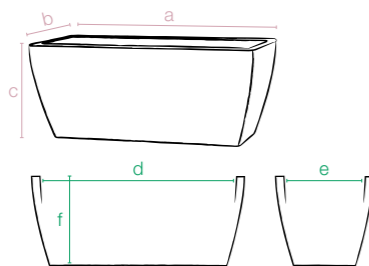

codice senza colore code without colour	Cm	dimensioni esterne external dimensions			dimensioni interne internal dimensions			litri liters	Confezione minima Minimum package	m ³	pezzi pallet pcs pallet	m ³
11 460 058	58	a58	b29	c25	d54	e25	f25	43	2 58x29x41h	0,06	52 80x120x230h	2,21
11 460 066	66	a66	b33	c28	d62	e29	f28	68	2 66x33x46h	0,10	33 80x120x230h	2,21
11 460 080	80	a79	b39	c33	d73	e33	f33	107	2 79x39x54h	0,16	27 80x120x230h	2,21



043

bianco/white
blanc/weiß



201

cappuccino/cappuccino
cappuccino/cappuccino



032

antracite/anthracite
anthracite/anthrazitgrau



039

bronzo/bronze
bronze/bronze

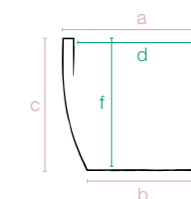

codice senza colore code without colour	Cm	dimensioni esterne external dimensions			dimensioni interne internal dimensions			litri liters	Confezione minima Minimum package	m ³	pezzi pallet pcs pallet	m ³
11 448 032	32	a32	b21	c27	d26	f25	11	2 32x32x48h	0,04	64 80x120x232h	2,23	
11 448 042	42	a42	b28	c35	d35	f33	26	2 42x42x63h	0,11	36 80x120x222h	2,13	
11 448 052	52	a52	b36	c43	d43	f40	49	2 52x52x80h	0,21	15 80x120x227h	2,72	
11 448 062	62	a62	b36	c50	d50	f44	64	2 62x62x88h	0,33	10 80x120x207h	1,99	



Pasubio quadro



Superficie opaca
Matt finished
Surface opaque
Matt-Oberfläche



Pasubio cassa



Superficie opaca
Matt finished
Surface opaque
Matt-Oberfläche



201

cappuccino/cappuccino
cappuccino/cappuccino

032

antracite/anthracite
anthracite/anthrazitgrau



201

cappuccino/cappuccino
cappuccino/cappuccino

032

antracite/anthracite
anthracite/anthrazitgrau

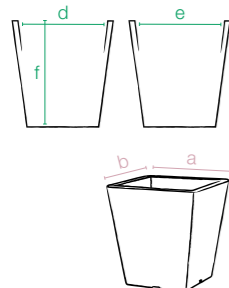

codice senza colore code without colour	Cm	dimensioni esterne external dimensions	dimensioni interne internal dimensions	litri liters	Confezione minima Minimum package	m ³	pezzi pallet pcs pallet	m ³
11 463 040	40	a40 b40 c42	d34 e34 f42	40	2 40x40x71h	0,11	24 80x120x210h	2,02

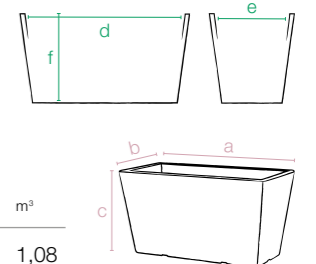

codice senza colore code without colour	Cm	dimensioni esterne external dimensions	dimensioni interne internal dimensions	litri liters	Confezione minima Minimum package	m ³	pezzi pallet pcs pallet	m ³
11 464 080	80	a80 b40 c42	d74 e34 f42	66	2 80x40x71h	0,22	12 80x120x112h	1,08



Pasubio alto



Superficie opaca
Matt finished
Surface opaque
Matt-Oberfläche



201

cappuccino/cappuccino
cappuccino/cappuccino



032

antracite/anthracite
anthracite/anthrazitgrau

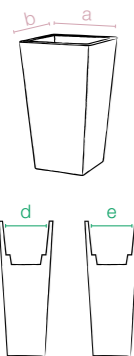

codice senza colore code without colour	Cm	dimensioni esterne external dimensions	dimensioni interne internal dimensions	litri liters	Confezione minima Minimum package	m ³	pezzi pallet pcs pallet	m ³	accessori accessories
11 462 070	70	a40 b40 c68	d34 e34 f25	31	1 40x40x70h	0,11	24 80x120x210h	2,02	
11 462 100	100	a40 b40 c100	d34 e34 f25	32	1 40x40x100h	0,16	12 80x120x212h	2,04	

Fix Ground
Fix Wall
pagina 300

Pasubio Alto,
Quadro e Cassa
componibili
modular
modulable
zusammensetzbar

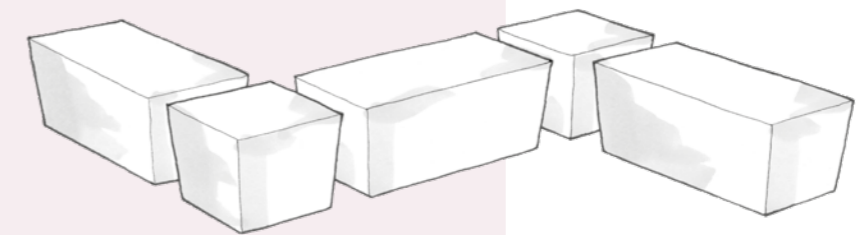

Pasubio Alto, Pasubio Quadro e Pasubio Cassa si prestano molto bene per organizzare gli spazi

Pasubio Quadro and Pasubio Cassa lend very well to organize spaces

Pasubio Quadro et Pasubio Cassa se prêtent très bien pour l'organisation des espaces

Pasubio Quadro und Pasubio Cassa sind ideal für die Organization der Räume

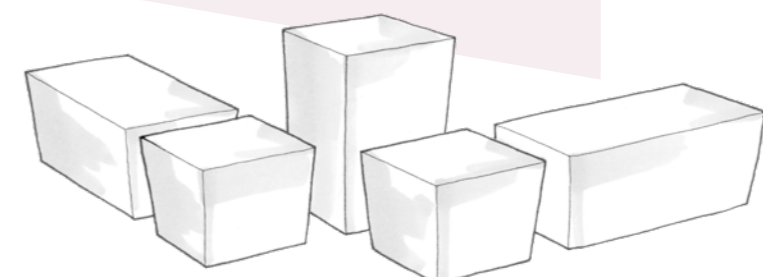
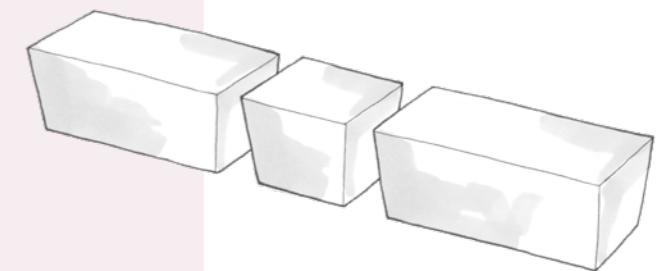
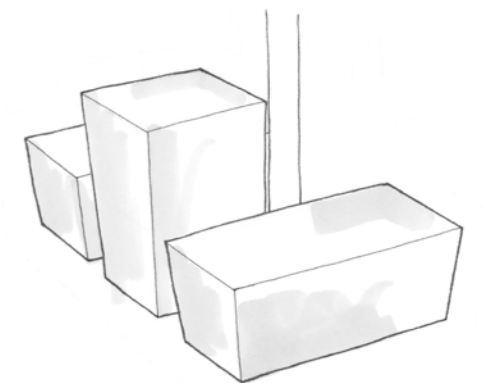



linea
CLASSIC



Flora



Cilindro Vicenza



Cassetta Liscia



Quadro Liscio



Africa



Tulipano



Vaso Festonato



Vaso Doppio Bordo



Campana Chiampo



Cassetta Leonardo



Cassetta Millerighe



Quadro Millerighe



Ciotola Castello



Conca Classica



Vaso Muro Righe



Vaso Muro Liscio



Sottovaso Muro



Sottovaso Tondo



Sottovaso Quadro



Sottocassetta



Superficie opaca
Matt finished
Surface opaque
Matt-Oberfläche



Superficie opaca
Matt finished
Surface opaque
Matt-Oberfläche



Flora

cilindro **Vicenza**



030

anticato/light brown
marron clair/hellbraun



201

cappuccino/cappuccino
cappuccino/cappuccino



032

antracite/anthracite
anthracite/anthrazitgrau



Sottovaso
pagina 274



030

anticato/light brown
marron clair/hellbraun



201

cappuccino/cappuccino
cappuccino/cappuccino



032

antracite/anthracite
anthracite/anthrazitgrau



Sottovaso
pagina 274

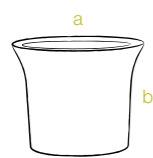

codice senza colore code without colour	Cm	dimensioni dimensions	litri liters		Confezione minima Minimum package	m³	pezzi pallet pcs pallet	m³
02 441 040	40	a40 b33	26	37	4 40x40x53h	0,08	72 80x120x115h	1,10
02 441 045	45	a45 b38	34	40	2 45x45x44h	0,08	125 100x120x224h	2,69
02 441 050	50	a50 b41	47	47	2 50x50x49h	0,12	64 100x120x220h	2,64

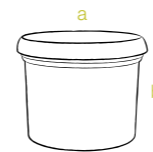

codice senza colore code without colour	Cm	dimensioni dimensions	litri liters		Confezione minima Minimum package	m³	pezzi pallet pcs pallet	m³
02 443 040	40	a40 b30	26	37	4 40x40x51h	0,08	66 80x120x115h	1,10
02 443 045	45	a45 b34	40	40	2 45x45x41h	0,08	75 80x120x220h	2,11
02 443 050	50	a50 b38	52	47	2 50x50x46h	0,11	66 100x120x225h	2,70
02 443 060	60	a60 b45	94	54	2 60x60x55h	0,19	34 80x120x214h	2,05
02 443 070	70	a70 b53	145	66	1 70x70x53h	0,26	15 80x80x224h	1,43



Superficie opaca
Matt finished
Surface opaque
Matt-Oberfläche



cassetta **Liscia**



Superficie opaca
Matt finished
Surface opaque
Matt-Oberfläche



quadro **Liscio**



030

anticato/light brown
marron clair/hellbraun



201

cappuccino/cappuccino
cappuccino/cappuccino



032

antracite/anthracite
anthracite/anthrazitgrau



Sottocassetta
pagina 275



030

anticato/light brown
marron clair/hellbraun



201

cappuccino/cappuccino
cappuccino/cappuccino



032

antracite/anthracite
anthracite/anthrazitgrau



Sottovaso
pagina 275

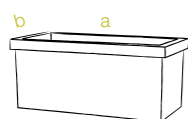

codice senza colore code without colour	Cm	dimensioni dimensions			litri liters		Confezione minima Minimum package	m ³	pezzi pallet pcs pallet		m ³
02 444 080	80	a 80	b 40	c 35	78	80	2 80x40x70h	0,22	18	80x120x224h	2,15
02 444 100	100	a 100	b 46	c 41	133	100	2 100x46x82h	0,37	10	100x120x220h	2,64

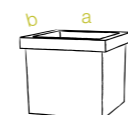

codice senza colore code without colour	Cm	dimensioni dimensions			litri liters		Confezione minima Minimum package	m ³	pezzi pallet pcs pallet		m ³
02 445 040	40	a 40	b 40	c 35	35	46	2 40x40x70h	0,11	18	80x120x117h	1,12
02 445 046	46	a 46	b 46	c 41	56	46	2 46x46x82h	0,17	20	100x120x219h	2,63
02 445 055	55	a 55	b 55	c 48	95	56	2 55x55x48h	0,29	16	120x120x207h	2,98



Africa

Superficie opaca / Matt finished
Surface opaque / Matt-Oberfläche



030

anticato/light brown
marron clair/hellbraun



201

cappuccino/cappuccino
cappuccino/cappuccino



032

antracite/anthracite
anthracite/anthrazitgrau

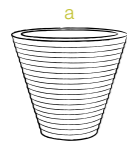

codice senza colore code without colour	Cm	dimensioni dimensions	litri liters	Confezione minima Minimum package	m ³	pezzi pallet pcs pallet	m ³
02 418 080	80	a 80 b 69	82	1 80x80x70h	0,44	5 80x80x213h	1,36
02 418 105	105	a 105 b 90	161	1 105x105x90h	0,99	4 100x120x238h	2,86

vaso Festonato

Superficie opaca / Matt finished
Surface opaque / Matt-Oberfläche



030

anticato/light brown
marron clair/hellbraun



201

cappuccino/cappuccino
cappuccino/cappuccino



032

antracite/anthracite
anthracite/anthrazitgrau



Sottovaso
pagina 274



codice senza colore code without colour	Cm	dimensioni dimensions	litri liters	Confezione minima Minimum package	m ³	pezzi pallet pcs pallet	m ³
02 400 030	30	a 30 b 16 c 25,1	8	4 30x30x46h	0,04	96 80x120x113h	1,08
02 400 035	35	a 35 b 20 c 29,5	15	4 35x35x52h	0,06	66 80x120x112h	1,08
02 400 040	40	a 40 b 22 c 34,6	22	4 40x40x61h	0,09	54 80x120x112h	1,08
02 400 045	45	a 45 b 26 c 38,8	34	2 45x45x48h	0,09	88 80x120x220h	2,11
02 400 050	50	a 50 b 28 c 43,3	46	2 50x50x52h	0,13	80 100x120x222h	2,66
02 400 055	55	a 55 b 32 c 47,8	67	2 55x55x59h	0,17	40 80x120x224h	2,15
02 400 060	60	a 60 b 35 c 53	84	2 60x60x62h	0,22	30 80x120x216h	2,07
02 400 070	70	a 70 b 40 c 58,1	123	1 70x70x59h	0,28	14 80x80x224h	1,43
02 400 080	80	a 80 b 43 c 62,9	245	1 80x80x63h	0,40	13 80x80x217h	1,39

Tulipano

Superficie opaca / Matt finished
Surface opaque / Matt-Oberfläche



030

anticato/light brown
marron clair/hellbraun



201

cappuccino/cappuccino
cappuccino/cappuccino



032

antracite/anthracite
anthracite/anthrazitgrau



codice senza colore code without colour	Cm	dimensioni dimensions	litri liters	Confezione minima Minimum package	m ³	pezzi pallet pcs pallet	m ³	accessori accessories
02 419 110	110	a 62,5 b 110	65	1 65x65x110h	0,46	6 100x120x230h	2,76	

Fix Ground
Fix Wall
pagina 300

vaso doppio bordo

Superficie opaca / Matt finished
Surface opaque / Matt-Oberfläche



030

anticato/light brown
marron clair/hellbraun



201

cappuccino/cappuccino
cappuccino/cappuccino



032

antracite/anthracite
anthracite/anthrazitgrau



Sottovaso
pagina 274



codice senza colore code without colour	Cm	dimensioni dimensions	litri liters	Confezione minima Minimum package	m ³	pezzi pallet pcs pallet	m ³
02 401 030	30	a 30 b 16,5 c 25,1	8	4 30x30x46h	0,04	96 80x120x115h	1,10
02 401 035	35	a 35 b 20 c 29,5	15	4 35x35x52h	0,06	60 80x120x113h	1,08
02 401 040	40	a 40 b 22 c 34,6	22	4 40x40x61h	0,09	48 80x120x112h	1,08
02 401 045	45	a 45 b 26 c 38,8	34	2 45x45x48h	0,09	80 80x120x220h	2,11
02 401 050	50	a 50 b 29 c 43,3	45	2 50x50x52h	0,13	76 100x120x228h	2,74
02 401 055	55	a 55 b 33 c 47,8	67	2 55x55x59h	0,17	36 80x120x220h	2,11
02 401 060	60	a 60 b 35 c 53	85	2 60x60x62h	0,22	30 80x120x219h	2,10
02 401 070	70	a 70 b 40 c 58,1	125	1 70x70x59h	0,28	14 80x80x219h	1,40
02 401 085	85	a 85 b 52,5 c 70	232	1 85x85x70h	0,50	11 100x120x215h	1,58

campana Chiampo

Superficie opaca / Matt finished
Surface opaque / Matt-Oberfläche



030
anticato/light brown
marron clair/hellbraun



201
cappuccino/cappuccino
cappuccino/cappuccino



032
antracite/anthracite
anthracite/anthrazitgrau



Sottovaso
pagina 264

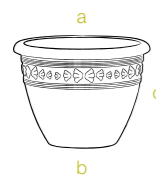

codice senza colore code without colour	Cm	dimensioni dimensions	litri liters	Confezione minima Minimum package	m ³	pezzi pallet pcs pallet	m ³
02 403 030	30	a30 b25,5 c23	8	4 30x30x51h	0,04	72 80x120x115h	1,10
02 403 040	40	a40 b33 c30,2	18	4 40x40x66h	0,10	42 80x120x115h	1,10
02 403 060	60	a60 b50 c47,1	65	2 60x60x67h	0,24	22 80x120x223h	2,23

cassetta Millerighe

Superficie opaca / Matt finished
Surface opaque / Matt-Oberfläche



030
anticato/light brown
marron clair/hellbraun



201
cappuccino/cappuccino
cappuccino/cappuccino



032
antracite/anthracite
anthracite/anthrazitgrau



Sottocassetta
pagina 265

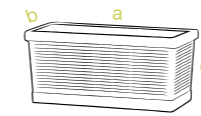

codice senza colore code without colour	Cm	dimensioni dimensions	litri liters	Confezione minima Minimum package	m ³	pezzi pallet pcs pallet	m ³
02 408 060	60	a59 b27 c27,6	32	2 59x27x56h	0,08	48 80x120x229h	2,20
02 408 080	80	a79 b34 c34	70	2 79x34x68h	0,18	18 80x120x221h	2,12
02 408 100	100	a100 b44 c40	146	2 100x44x80h	0,35	10 100x120x228h	2,74

cassetta Leonardo

Superficie opaca / Matt finished
Surface opaque / Matt-Oberfläche



030
anticato/light brown
marron clair/hellbraun



201
cappuccino/cappuccino
cappuccino/cappuccino



032
antracite/anthracite
anthracite/anthrazitgrau



Sottocassetta
pagina 265

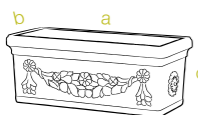

codice senza colore code without colour	Cm	dimensioni dimensions	litri liters	Confezione minima Minimum package	m ³	pezzi pallet pcs pallet	m ³
02 406 060	60	a58 b29 c27	29	2 58x29x54h	0,09	48 80x120x220h	2,11
02 406 080	80	a80 b34 c32	57	2 80x34x64h	0,17	18 80x120x202h	1,94
02 406 100	100	a100 b45 c40	120	2 100x45x80h	0,36	10 100x120x212h	2,54

quadro Millerighe

Superficie opaca / Matt finished
Surface opaque / Matt-Oberfläche



030
anticato/light brown
marron clair/hellbraun



201
cappuccino/cappuccino
cappuccino/cappuccino



032
antracite/anthracite
anthracite/anthrazitgrau



Sottovaso
pagina 265

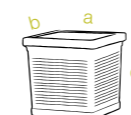

codice senza colore code without colour	Cm	dimensioni dimensions	litri liters	Confezione minima Minimum package	m ³	pezzi pallet pcs pallet	m ³
02 409 035	35	a35 b35 c34,6	28	2 35x35x70h	0,08	36 80x120x218h	2,09
02 409 040	40	a40 b40 c39,6	41	2 40x40x80h	0,12	30 80x120x207h	1,99
02 409 045	45	a45 b45 c40,1	59	2 45x45x81h	0,16	20 100x120x235h	2,82

ciotola **Castello**

Superficie opaca / Matt finished
Surface opaque / Matt-Oberfläche



030

anticato/light brown
marron clair/hellbraun



201

cappuccino/cappuccino
cappuccino/cappuccino



032

antracite/anthracite
anthracite/anthrazitgrau



codice senza colore code without colour	Cm	dimensioni dimensions	litri liters	Confezione minima Minimum package	m ³	pezzi pallet pcs pallet	m ³
02 405 050	50	a50 b22	24	2 50x50x33h	0,08	32 80x120x115h	1,10
02 405 060	60	a60 b24,5	42	2 60x60x40h	0,14	12 80x120x115h	1,10
02 405 080	80	a80 b35	97	1 80x80x35h	0,22	11 80x80x210h	1,34

vaso **Muro righe**

Superficie opaca / Matt finished
Surface opaque / Matt-Oberfläche



030

anticato/light brown
marron clair/hellbraun



201

cappuccino/cappuccino
cappuccino/cappuccino



032

antracite/anthracite
anthracite/anthrazitgrau

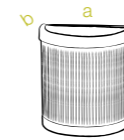

codice senza colore code without colour	Cm	dimensioni dimensions	Confezione minima Minimum package	m ³	pezzi pallet pcs pallet	m ³
02 413 048	48	a48 b32 c52	53	1 48x32x52h	0,08	14 100x120x118h 1,42

conca **Classica**

Superficie opaca / Matt finished
Surface opaque / Matt-Oberfläche



030

anticato/light brown
marron clair/hellbraun



201

cappuccino/cappuccino
cappuccino/cappuccino



032

antracite/anthracite
anthracite/anthrazitgrau

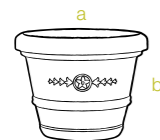

codice senza colore code without colour	Cm	dimensioni dimensions	litri liters	Confezione minima Minimum package	m ³	pezzi pallet pcs pallet	m ³
02 412 120	120	a120 b94	541	1 120x120x95h	1,36	6 120x120x197h	2,84

vaso **Muro liscio**

Superficie opaca / Matt finished
Surface opaque / Matt-Oberfläche



030

anticato/light brown
marron clair/hellbraun



201

cappuccino/cappuccino
cappuccino/cappuccino



032

antracite/anthracite
anthracite/anthrazitgrau



codice senza colore code without colour	Cm	dimensioni dimensions	Confezione minima Minimum package	m ³	pezzi pallet pcs pallet	m ³
02 414 050	48	a48 b32 c52	53	1 48x32x52h	0,08	14 100x120x118h 1,42

sottovaso Muro

Superficie opaca / Matt finished
Surface opaque / Matt-Oberfläche

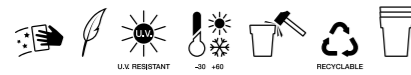

030

anticato/light brown
marron clair/hellbraun



201

cappuccino/cappuccino
cappuccino/cappuccino



032

antracite/anthracite
anthracite/anthrazitgrau

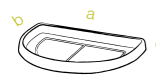

codice senza colore code without colour	Cm	dimensioni dimensions	Confezione minima Minimum package	m ³	pezzi pallet pcs pallet	m ³
02 429 053	53	a53 b38 c4,5	1 53x38x5h	0,01	135 80x120x115h	1,10

sottovaso Tondo

Superficie opaca / Matt finished
Surface opaque / Matt-Oberfläche

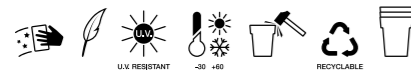

043

bianco/white
blanc/weiß



030

anticato/light brown
marron clair/hellbraun



201

cappuccino/cappuccino
cappuccino/cappuccino



032

antracite/anthracite
anthracite/anthrazitgrau



050

rosso cardinale/cardinal red
rouge cardinal/scharlachrot



039

bronzo/bronze
bronze/bronze

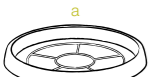

codice senza colore code without colour	Cm	dimensioni dimensions	Confezione minima Minimum package	m ³	pezzi pallet pcs pallet	m ³
02 415 022	22	a22 b4,1	10 22x22x18h	0,01	600 80x120x115h	1,10
02 415 027	27	a27 b4,1	10 27x27x22h	0,01	550 80x120x115h	1,10
02 415 030	30	a30 b4,1	8 30x30x15h	0,01	320 80x120x115h	1,10
02 415 033	33	a33 b4,1	8 33x33x15h	0,02	336 80x120x115h	1,10
02 415 037	37	a37 b4,1	8 37x37x15h	0,02	288 80x120x115h	1,10
02 415 040	40	a40 b5,1	8 40x40x15h	0,03	288 80x120x115h	1,10
02 415 047	47	a47 b5,1	6 47x47x14h	0,03	180 80x120x115h	1,10
02 415 050	50	a50 b5,1	6 50x50x14h	0,03	180 80x120x115h	1,10
02 415 054	54	a54 b5,1	4 54x54x11h	0,03	120 80x120x115h	1,10
02 415 060	60	a60 b5,1	4 60x60x11h	0,04	92 80x120x115h	1,10
02 415 066	66	a66 b6	4 66x66x13h	0,05	46 80x120x115h	1,10

sottovaso Quadro

Superficie opaca / Matt finished
Surface opaque / Matt-Oberfläche

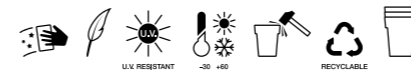

043

bianco/white
blanc/weiß



030

anticato/light brown
marron clair/hellbraun



201

cappuccino/cappuccino
cappuccino/cappuccino



032

antracite/anthracite
anthracite/anthrazitgrau



050

rosso cardinale/cardinal red
rouge cardinal/scharlachrot



039

bronzo/bronze
bronze/bronze

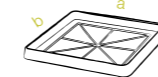

codice senza colore code without colour	Cm	dimensioni dimensions	Confezione minima Minimum package	m ³	pezzi pallet pcs pallet	m ³
02 417 030	30	a30 b30 c5,1	2 30x30x7h	0,01	270 80x120x115h	1,10
02 417 036	36	a36 b36 c5,1	2 36x36x7h	0,01	270 80x120x115h	1,10
02 417 046	46	a46 b46 c5,1	2 46x46x7h	0,01	80 80x120x115h	1,10
02 417 056	56	a56 b56 c5,1	2 56x56x7h	0,02	80 80x120x115h	1,10

Sottocassetta

Superficie opaca / Matt finished
Surface opaque / Matt-Oberfläche

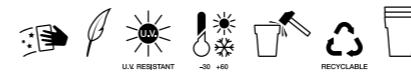

043

bianco/white
blanc/weiß



030

anticato/light brown
marron clair/hellbraun



201

cappuccino/cappuccino
cappuccino/cappuccino



032

antracite/anthracite
anthracite/anthrazitgrau

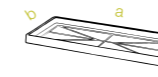

codice senza colore code without colour	Cm	dimensioni dimensions	Confezione minima Minimum package	m ³	pezzi pallet pcs pallet	m ³
02 416 060	60	a60 b30 c5,1	2 60x31x7h	0,01	120 80x120x115h	1,10
02 416 080	80	a80 b36 c5,1	2 80x36x7h	0,02	80 80x120x115h	1,10
02 416 100	100	a100 b45 c5,1	2 100x45x7h	0,03	38 80x120x115h	1,10



linea
CITY



New York



Venezia



Roma

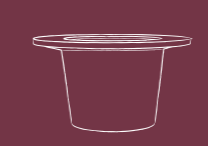

A-Malo



Loft



Sweep



Superficie opaca
Matt finished
Surface opaque
Matt-Oberfläche



New York

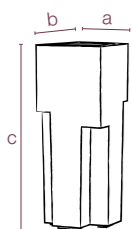
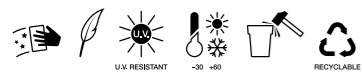

codice senza colore code without colour	Cm	dimensioni esterne external dimensions	Confezione minima Minimum package	m ³	pezzi pallet pcs pallet	m ³	accessori accessories
20 454 100	043 037 100	a39 b39 c100	1 40x40x102h	0,16	12 80x120x215h	2,06	

Fix Wall
pagina 301



Superficie opaca
Matt finished
Surface opaque
Matt-Oberfläche



Venezia

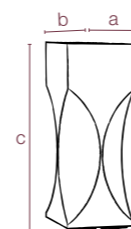
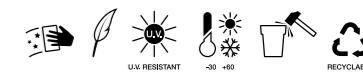

codice senza colore code without colour	Cm	dimensioni esterne external dimensions	Confezione minima Minimum package	m ³	pezzi pallet pcs pallet	m ³	accessori accessories
20 459 100	043 037 100	a39 b39 c100	1 40x40x102h	0,16	12 80x120x215h	2,06	

Fix Wall
pagina 301



Superficie opaca
Matt finished
Surface opaque
Matt-Oberfläche



Roma

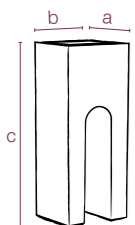
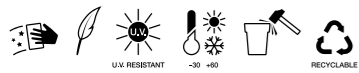

codice senza colore code without colour	Cm	dimensioni esterne external dimensions	Confezione minima Minimum package	m ³	pezzi pallet pcs pallet	m ³	accessori accessories
20 455 100	043 037	100	a39 b39 c100	1	40x40x102h	0,16	12 80x120x215h 2,06

Fix Wall
pagina 301



Superficie opaca
Matt finished
Surface opaque
Matt-Oberfläche

A-malo

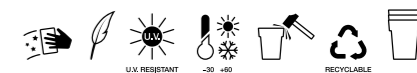

Sistema di aggancio
Coupling system
Système d'accrochage
Aufhäng System



Articolo composto da due pezzi per agevolare il trasporto
The item is made up of two components to facilitate the transport
Article composé de 2 pièces pour faciliter le transport
Artikel besteht aus zwei teilen um der Transport zu erleichtern

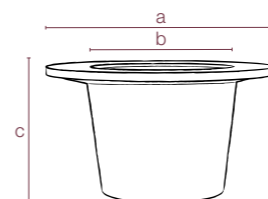

codice senza colore code without colour	Cm	dimensioni dimensions	Confezione minima Minimum package
20 458 150 vaso	043 037	150	b108 c110
20 452 150 anello	043 037	150	a150 c8
20 458 220 vaso	043 037	220	b158 c120
20 452 220 anello	043 037	220	a220 c10



Superficie opaca
Matt finished
Surface opaque
Matt-Oberfläche



Superficie opaca
Matt finished
Surface opaque
Matt-Oberfläche



Loft

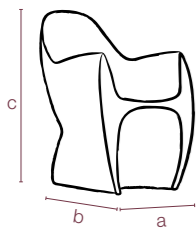
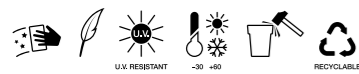

codice senza colore code without colour	Cm	dimensioni esterne external dimensions	Confezione minima Minimum package	m ³
54 513 085	043 037 65	a65 b65 c85	1 65x65x85h	0,36

colour on demand 050 201 202 232 030 068

Sweep

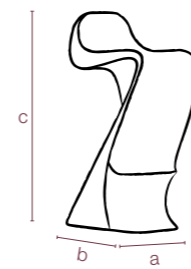
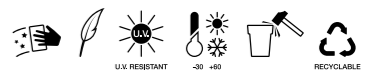

codice senza colore code without colour	Cm	dimensioni esterne external dimensions	Confezione minima Minimum package	m ³
54 514 088	043 037 88	a45 b42 c88	1 45x42x88h	0,16

colour on demand 050 201 202 232 030 068



linea
LUCE



Standard One
Outdoor



Spritz



Africa Outdoor



Tulipano Outdoor



Valentino
Outdoor



Pasubio Alto
Outdoor



Bassano
Outdoor



Schio Cassa Alta
Outdoor



Schio Cubo Alto
Outdoor



Schio Cono
Outdoor



Superficie opaca
Matt finished
Surface opaque
Matt-Oberfläche



Superficie opaca
Matt finished
Surface opaque
Matt-Oberfläche



Standard one outdoor

Spritz

caratteristiche lampada: attacco E27, tensione max 220, potenza max 11 W, tipo risp. energ. standard
lamp characteristics: electrical coupling E27, max voltage 220, max electrical power 11 W, standard energy saving type lamp
caractéristiques de l'ampoule: culot E27, tension max 220, puissance max 11W, type économie d'énergie standard
charakteristik der Lampe E27 Fassung, max. 220 Volt max. 11 W. Energiesparlampe Typ Standard



caratteristiche lampada: attacco E27, tensione max 220, potenza max 11 W, tipo risp. energ. standard
lamp characteristics: electrical coupling E27, max voltage 220, max electrical power 11 W, standard energy saving type lamp
caractéristiques de l'ampoule: culot E27, tension max 220, puissance max 11W, type économie d'énergie standard
charakteristik der Lampe E27 Fassung, max. 220 Volt max. 11 W. Energiesparlampe Typ Standard

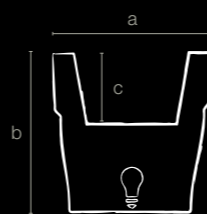
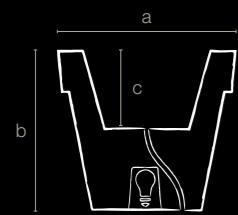

Fix Wall
pagina 301

Fix Wall
pagina 301

codice senza colore code without colour	Cm	dimensioni dimensions			litri liters	Confezione minima Minimum package	m ³	pezzi pallet pcs pallet	m ³	accessori accessories
13 437 070	033 70	a70	b63	c17	43	1 70x70x63h	0,30	4 80x80x220h	1,40	
13 437 080	033 80	a80	b72	c19	67	1 80x80x72h	0,40	4 80x80x220h	1,40	
13 437 100	033 100	a100	b90	c24	123	1 100x100x90h	0,90	3 100x120x220h	2,60	
13 437 120	033 120	a120	b108	c30	191	1 120x120x108h	1,50	2 120x120x220h	3,10	

codice senza colore code without colour	Cm	dimensioni dimensions			litri liters	Confezione minima Minimum package	m ³	pezzi pallet pcs pallet	m ³	accessori accessories
05 446 038	033 38	a38	b35	c16,5	43	1 40x40x63h	0,06	18 80x120x130h	1,20	



Superficie opaca
Matt finished
Surface opaque
Matt-Oberfläche



Superficie opaca
Matt finished
Surface opaque
Matt-Oberfläche



Africa outdoor

Tulipano outdoor

caratteristiche lampada: attacco E27, tensione max 220, potenza max 11 W, tipo risp. energ. standard

lamp characteristics: electrical coupling E27, max voltage 220, max electrical power 11 W, standard energy saving type lamp

caractéristiques de l'ampoule: culot E27, tension max 220, puissance max 11W, type économie d'énergie standard

charakteristik der Lampe E27 Fassung, max. 220 Volt max. 11 W. Energiesparlampe Typ Standard

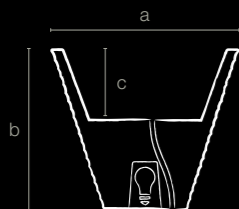

caratteristiche lampada: attacco E27, tensione max 220, potenza max 11 W, tipo risp. energ. standard

lamp characteristics: electrical coupling E27, max voltage 220, max electrical power 11 W, standard energy saving type lamp

caractéristiques de l'ampoule: culot E27, tension max 220, puissance max 11W, type économie d'énergie standard

charakteristik der Lampe E27 Fassung, max. 220 Volt max. 11 W. Energiesparlampe Typ Standard

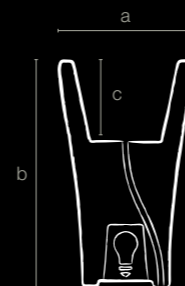

codice senza colore code without colour	Cm	dimensioni dimensions	litri liters	Confezione minima Minimum package	m ³	pezzi pallet pcs pallet	m ³
13 418 080	033 80	a 80 b 69 c 36	82	1 80x80x70h	0,45	5 80x80x216h	1,40
13 418 105	033 105	a 105 b 90 c 42	161	1 105x105x90h	1,00	4 100x120x238h	2,86

codice senza colore code without colour	Cm	dimensioni dimensions	litri liters	Confezione minima Minimum package	m ³	pezzi pallet pcs pallet	m ³	accessori accessories
13 419 110	033 110	a 65 b 110 c 39	65	1 65x65x110h	0,50	6 100x120x230h	0,76	

Fix Wall
pagina 301





Valentino outdoor

Superficie opaca
Matt finished
Surface opaque
Matt-Oberfläche

Superficie opaca
Matt finished
Surface opaque
Matt-Oberfläche

Pasubio alto outdoor

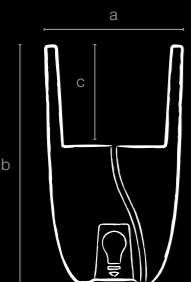

codice senza colore code without colour	Cm	dimensioni dimensions			litri liters	Confezione minima Minimum package	m ³	pezzi pallet pcs pallet	m ³	accessori accessories
13 432 050	50	a34	b50	c22	10	1 34x34x50h	0,06	16 80x120x112h	1,10	
13 432 070	70	a42	b70	c28	17	1 42x42x70h	0,10	18 80x120x226h	2,20	
13 432 090	90	a52	b90	c30	29	1 52x52x90h	0,20	8 100x120x195h	2,30	

Fix Ground
Fix Wall
pagina 300

caratteristiche lampada: attacco E27, tensione max 220, potenza max 11 W, tipo risp. energ. standard
lamp characteristics: electrical coupling E27, max voltage 220, max electrical power 11 W, standard energy saving type lamp
caractéristiques de l'ampoule: culot E27, tension max 220, puissance max 11W, type économie d'énergie standard
charakteristik der Lampe E27 Fassung, max. 220 Volt max. 11 W. Energiesparlampe Typ Standard

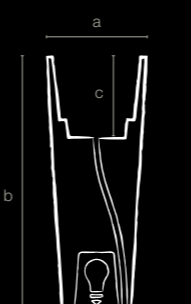

codice senza colore code without colour	Cm	dimensioni dimensions			litri liters	Confezione minima Minimum package	m ³	pezzi pallet pcs pallet	m ³	accessori accessories
13 462 070	70	a40	b68	c25	31	1 40x40x70h	0,10	24 80x120x210h	2,00	
13 462 100	100	a40	b100	c39	32	1 40x40x100h	0,10	12 80x120x212h	2,00	

Fix Ground
Fix Wall
pagina 300

caratteristiche lampada: attacco E27, tensione max 220, potenza max 11 W, tipo risp. energ. standard
lamp characteristics: electrical coupling E27, max voltage 220, max electrical power 11 W, standard energy saving type lamp
caractéristiques de l'ampoule: culot E27, tension max 220, puissance max 11W, type économie d'énergie standard
charakteristik der Lampe E27 Fassung, max. 220 Volt max. 11 W. Energiesparlampe Typ Standard





Superficie opaca
Matt finished
Surface opaque
Matt-Oberfläche



Superficie opaca
Matt finished
Surface opaque
Matt-Oberfläche



Bassano outdoor

Schio cassa alta outdoor

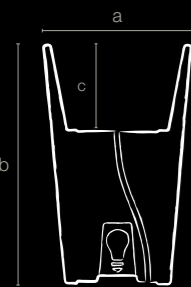

caratteristiche lampada: attacco E27, tensione max 220, potenza max 11 W, tipo risp. energ. standard
lamp characteristics: electrical coupling E27, max voltage 220, max electrical power 11 W, standard energy saving type lamp
caractéristiques de l'ampoule: culot E27, tension max 220, puissance max 11W, type économie d'énergie standard
charakteristik der Lampe E27 Fassung, max. 220 Volt max. 11 W. Energiesparlampe Typ Standard

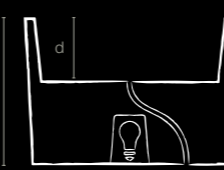
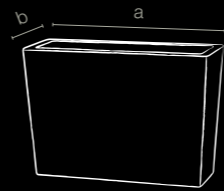

caratteristiche lampada: attacco E27, tensione max 220, potenza max 11 W, tipo risp. energ. standard
lamp characteristics: electrical coupling E27, max voltage 220, max electrical power 11 W, standard energy saving type lamp
caractéristiques de l'ampoule: culot E27, tension max 220, puissance max 11W, type économie d'énergie standard
charakteristik der Lampe E27 Fassung, max. 220 Volt max. 11 W. Energiesparlampe Typ Standard



codice senza colore code without colour	Cm	dimensioni dimensions	litri liters	Confezione minima Minimum package	m ³	pezzi pallet pcs pallet	m ³	accessori accessories
13 423 060	033 60	a45 b60 c20	17	1 45x45x60h	0,10	12 100x120x200h	2,40	
13 423 100	033 100	a60 b100 c39	48	1 60x60x100h	0,30	4 80x120x220h	2,10	

Fix Ground
Fix Wall
pagina 300

codice senza colore code without colour	Cm	dimensioni dimensions	litri liters	Confezione minima Minimum package	m ³	pezzi pallet pcs pallet	m ³
13 428 050	033 50	a50 b36 c70 d29	31	1 50x36x70h	0,10	12 80x120x222h	2,10
13 428 100	033 100	a100 b36 c70 d29	70	1 100x36x70h	0,20	6 80x120x222h	2,10



Schio cubo alto outdoor

Superficie opaca
Matt finished
Surface opaque
Matt-Oberfläche

Superficie opaca
Matt finished
Surface opaque
Matt-Oberfläche

Schio cono outdoor

caratteristiche lampada: attacco E27, tensione max 220, potenza max 11 W, tipo risp. energ. standard
lamp characteristics: electrical coupling E27, max voltage 220, max electrical power 11 W, standard energy saving type lamp
caractéristiques de l'ampoule: culot E27, tension max 220, puissance max 11W, type économie d'énergie standard
charakteristik der Lampe E27 Fassung, max. 220 Volt max. 11 W. Energiesparlampe Typ Standard

caratteristiche lampada: attacco E27, tensione max 220, potenza max 11 W, tipo risp. energ. standard
lamp characteristics: electrical coupling E27, max voltage 220, max electrical power 11 W, standard energy saving type lamp
caractéristiques de l'ampoule: culot E27, tension max 220, puissance max 11W, type économie d'énergie standard
charakteristik der Lampe E27 Fassung, max. 220 Volt max. 11 W. Energiesparlampe Typ Standard

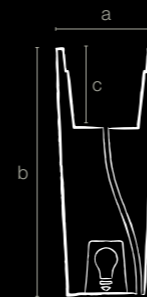
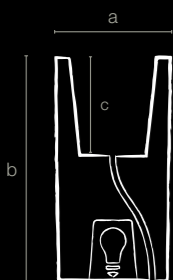

codice senza colore code without colour	Cm	dimensioni dimensions	litri liters	Confezione minima Minimum package	m ³	pezzi pallet pcs pallet	m ³	accessori accessories
13 426 080	033	80	a40 b80 c34,5	31	1	40x40x80h	0,10	15 80x120x212h 2,00

Fix Wall
pagina 301

codice senza colore code without colour	Cm	dimensioni dimensions	litri liters	Confezione minima Minimum package	m ³	pezzi pallet pcs pallet	m ³	accessori accessories
13 424 070	033	70	a30 b68 c20	8	1	30x30x68h	0,06	24 80x120x225h 2,10
13 424 090	033	90	a40 b90 c35	26	1	40x40x90h	0,10	12 80x120x195h 1,80
13 424 110	033	110	a45 b110 c35	35	1	45x45x110h	0,20	12 80x120x236h 2,20
13 424 145	033	145	a55 b145 c31	46	1	55x55x145h	0,40	4 100x120x160h 1,90

Fix Ground
Fix Wall
pagina 300





A-malo luce outdoor

Superficie opaca
Matt finished
Surface opaque
Matt-Oberfläche



Led

Sistema di aggancio
Coupling system
Système d'accrochage
Aufhäng System

l'anello del vaso a-malo è dotato di una striscia led
the ring of pot a-malo is equipped with LED strip
l'anneau du pot A-malo est équipé de bande de LED
Der Ring vom Topf A-Malo ist mit LED-Streifen zur Beleuchtung ausgestattet

a

codice senza colore code without colour	Cm	dimensioni dimensions	Confezione minima Minimum package
13 452 150 anello luce	043 037 150	a 150	1 150x150x8h 0,18
13 452 220 anello luce	043 037 220	a 220	1 158x158x120h 2,99

Per installazione all'esterno. Certificati CE, classe di isolamento IP55, completi di cavo di alimentazione, presa bipolare, lampada. Non sono dotati di interruttore. Si consiglia che l'installazione all'esterno venga effettuata da personale qualificato. Le versioni outdoor sono dotate di un foro e un tubo per il drenaggio dell'acqua che si potrà accumulare nel contenitore. È fondamentale che il foro e il tubo non vengano ostruiti in modo tale da permettere un sicuro drenaggio. Per questo consigliamo di non mettere mai la pianta o la terra direttamente nel contenitore ma di posizionare sempre un sottovaso e un vaso di contenimento di dimensioni appropriate. Pulire frequentemente il foro e il tubo di drenaggio.

For outdoor installation. Certificates CE, IP55 dielectric strength class, complete with power cord, hole plug, lamp. Not equipped with a switch. It is recommended that the installation is made by qualified personnel. The outdoor version is equipped with a hole and a tube to drain water that might be accumulated in the container. It is important that the hole and the tube will not be obstructed

so as to allow safe drainage. Therefore we recommend to never put the plant or the soil directly in the container but always place a saucer and a pot of appropriate sizes. Never put the soil or plant directly into the container. In this way you risk to obstruct the hole and the drainage tube compromising their operation and safety. Please clean frequently the hole and the drainage tube.

Ne jamais mettre la terre ou la plante directement dans le recipient. De cette manière il peut s'obstruer l'orifice et le tuyau de drainage en compromettant le fonctionnement et la sûreté. Mettre toujours un sous-vase ou un vase de la dimension appropriées à la plante. Nettoyer souvent le trou et le tube de drainage.

fonctionnement et la sûreté. Mettre toujours un sous-vase ou un vase de la dimension appropriées à la plante. Nettoyer souvent le trou et le tube de drainage.

Niemals Erde oder Pflanzen direkt in den Behälter setzen. Sie riskieren, dass Öffnung und Rohr der Drainage verstopfen und somit die Funktion und Sicherheit nicht gewährleistet ist. Benutzen Sie stets Pflanztopfuntersetzer oder Töpfe mit angepasster Größe für Behälter und Pflanze. Reinigen Sie regelmäßig Öffnung und Rohr der Drainage. Sie riskieren, dass Öffnung und Rohr der Drainage verstopfen und somit die Funktion und Sicherheit nicht gewährleistet ist. Reinigen Sie regelmäßig Öffnung und Rohr der Drainage.

Luce inclusa White cold lamp Ampoule à blanche Lampe weiss



Per tutti gli articoli della linea Luce è possibile acquistare come supplemento la lampadina LED, disponibile in due versioni:

For all items of the collection Luce it is possible to buy an additional LED lamp, of which two options are available:

Pour tous les articles de la ligne Luce il est possible d'acheter à part l'ampoule led disponible en deux versions:

Für alle Artikel der Linie Luce besteht die Möglichkeit die LED Lampen in zwei Versionen zu erwerben:

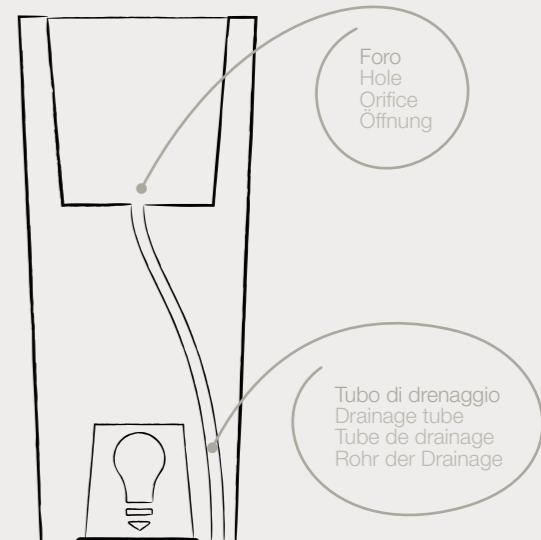

Luce led bianca optional Additional led lamp Ampoule à leds supplémentaire Zusatz led Lampe



codice senza colore
code without colour

10 906 000

Confezione minima
Minimum package

1



Luce led multicolor con telecomando optional
Multicoloured led lamp with remote control
Ampoule à leds à couleurs changeantes avec télécommande
Lampe led multicolor mit Fernbedienung

codice senza colore
code without colour

10 907 000

Confezione minima
Minimum package

1

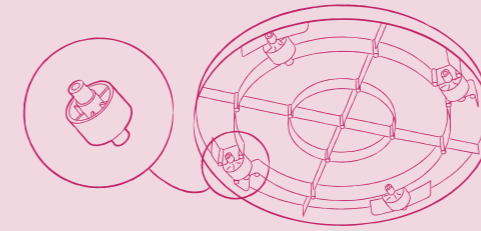

Mover è dotato di ruote bidirezionali ad incastro.

Mover has got bidirectional wheels.

Le Mover a les roues bidirectionnels.

Der Mover hat bidirektionale Räder.

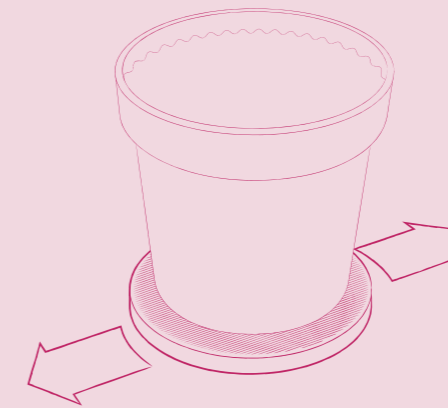

50 kg
110 lb
MAX



005
antracite/anthracite
anthracite/anthrazitgrau

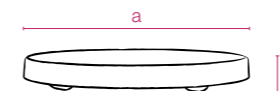

codice senza colore code without colour	Cm	dimensioni dimensions	Confezione minima Minimum package	m ³	pezzi pallet pcs pallet	m ³
10 121 029	29	a 29 b 2,6	30 58X29X41h	0,07	240 80x120x100h	1,15
10 121 034	34	a 34 b 2,6	15 34X34X41h	0,05	180 80x120x100h	1,15
10 121 039	39	a 39 b 2,6	14 39X39X41h	0,06	180 80x120x100h	1,15



Superficie opaca
Matt finished
Surface opaque
Matt-Oberfläche



Mover

Fix Ground round

ACCESSORI: articoli molto semplici ma di sicuro utilizzo. Fissati a una parete o sul pavimento riducono notevolmente le possibilità di ribaltamento accidentale.

ACCESSORIES: items very simple but certainly used. Attached to a wall or lying on the floor they reduced significantly the possibility of rollover accident.

ACCESSOIRES: des articles très simples mais sûrement utiles. Fixés au mur ou au plancher, ils réduisent considérablement le risque de renversement accidentel.

ZUBEHÖR: diese Artikel sind sehr einfach aber ganz sicherlich nützlich. Festgeschraubt auf einer Wand oder auf dem Boden, reduzieren sie stark das Umkippenrisiko.

codice senza colore code without colour	Cm	dimensioni dimensions	Confezione minima Minimum package	m ³
10 903 041	41	a41 b0,5	2 42x42x4h	0,01
10 903 048	48	a48 b0,5	2 50x50x4h	0,01
10 903 060	60	a60 b0,5	2 62x62x4h	0,01

Fix Ground square

codice senza colore code without colour	Cm	dimensioni dimensions	Confezione minima Minimum package	m ³
10 908 039	39	a39 b0,5	2 40x40x4h	0,01

Fix Wall

codice senza colore code without colour	Cm	dimensioni dimensions	Confezione minima Minimum package	m ³
10 904 007	7	a25 b7 c3 d0,5	2 25x15x5h	0,002

Il lucchetto non è incluso
Padlock not included
Cadenas non inclus
Vorhängeschloss nicht inklusive



Colori on Demand

Colours on Demand

Farben auf Anfrage

Couleurs sur Demande

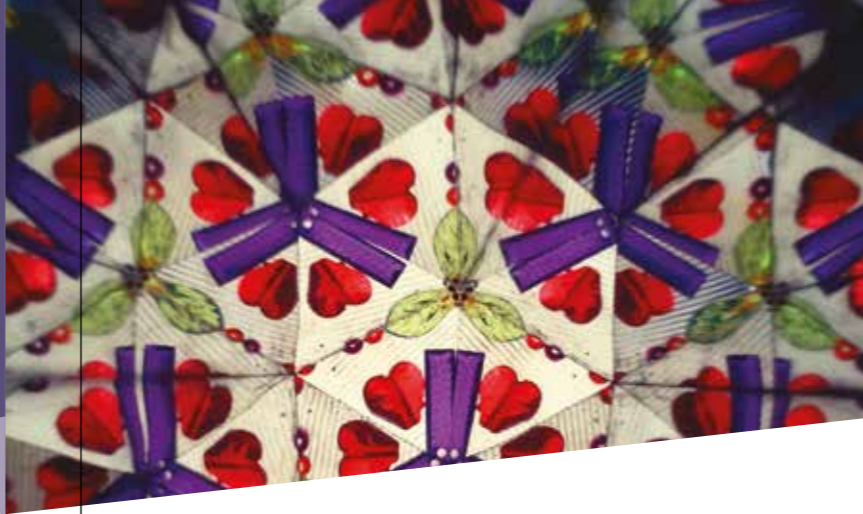

024	trasparente / transparent
022	bianco / white
012	argento / silver
008	sabbia / sand colour
013	giallo / yellow
419	giallo / yellow
011	oro / gold
016	arancio / orange
010	rosso / red
014	rosso intenso / intense red
416	marsala / marsala
020	bronzo / bronze
018	ciclaminio / cyclamen
401	peonia / peony
019	lilla / lilac
402	lilyum / lilyum
009	viola / violet
405	bambù / bamboo
404	cedro / cedar
007	verde / green
407	salvia / sage
002	verde / green
028	turchese / turquoise
015	azzurro / light blue
017	blu / blue
403	corda / cord
417	aluminium / aluminium
406	bruno / brown
415	terra di Siena / terra di siena
408	cacao / cacao
001	terraccotta / terracotta colour

414	fog grey / fog grey
005	brouillard gris / Nebel grau
006	anthracite / anthracite
003	nero / black
412	acqua marina / aquamarine
410	ghiaccio / ice
409	malva / mauve
411	porcellana / porcelain
043	bianco / white
033	bianco neutro / neutral white
071	bianco lucido / gloss white
034	arancio / orange
030	anticato / light brown
048	rosso / red
050	rosso cardinale / cardinal red
070	rosso lucido / gloss red
042	fucsia / fuchsia
231	fucsia / fuchsia
068	fucsia / fuchsia
211	melanzana / aubergine
234	malva / mauve
202	lavanda / lavender
203	lime / lime
232	kiwi / kiwi
208	menta / mint
041	verde mela / green apple
230	cielo / sky blue
204	grigio seta / silk grey
201	capuccino / cappuccino
233	torfee / toffee
049	grigio fumo / smoke grey
039	bronzo / bronze
210	grafite / graphite
235	beton / beton
032	anthracite / anthracite
037	nero / black
072	nero lucido / gloss black

INIEZIONE

ROTAZIONALE

INIEZIONE

- Linea Re
- Linea Teraguard
- Linea Elements
- Linea Clear
- Linea Pastel
- Linea Colour
- Linea Basic
- T-basket
- Linea Flortec

ROTAZIONALE

- Linea Groove
- Linea Essential
- Self Watering
- Linea Classic
- Linea City
- Linea Luce

Colori on Demand
da concordare con la rete vendita
minimi d'ordine e quantità.

Colours on Demand to be agreed
with the Sales network, minimum
order quantity and prices.

Farben auf Anfrage. Mindestbe-
stellmenge und Preise müssen mit
den Vertretern vereinbart werden.

Couleurs sur demande à définir
avec le réseau commercial, mini-
mum commande et prix.

Progetto grafico ed impaginazione:

Verde Pistacchio - info@verdepistacchio.net
da pag. 8 a pag. 47 studiomama - info@studiomama.it

Le ambientazioni:

Alexis visual arts - Via Giovanni Dolfin, 8 - 36016 Thiene (VI) - www.alexisvisual.com
Verde Architettura - via Fumagalli, 7 - 20143 (MI) - www.verdearchitettura.it
Anymotion - Corso Garibaldi, 81 - 29017 Fiorenzuola D'Arda (PC)

Foto:

Photopiù - Via Rivarotta, 165 - 36061 Bassano del Grappa (VI) - www.photopiu.it
BitCreativo di Mazzaro Elia - Via Col di Lana, 10 - 36034 Malo (VI) - www.bitcreativo.it
Emanuele Tortora Photography - www.emanueletortora.it

Designer:

favarettoandpartner
Irina Alekseeva

Dati, foto e caratteristiche non sono impegnativi; Teraplast si riserva di apportare le modifiche che riterrà opportune per migliorare i suoi prodotti.
Tutte le parti di questo catalogo - foto comprese - sono di proprietà di Teraplast. La riproduzione, anche parziale, è vietata in ogni forma e con ogni mezzo.

Data, photos, and characteristics are not binding; Teraplast reserves the right to produce modifications considered necessary to improve its products.
Every part of this catalogue - photos included - is the property of Teraplast. All forms of copying are strictly prohibited.

TeraPlast™ S.p.a.

Via del Progresso, 65 (GPS: Località Conca)
36070 Castelgomberto (VI) - ITALY
tel. +39 0445 444 100 - fax +39 0445 444 111
www.teraplast.com - info@teraplast.com

